

# V 10

## HIGH POWER, TWO-WAY BASS REFLEX FULL RANGE SYSTEM

### DESCRIPTION

The V10 is a compact, full range, extremely versatile two-way loudspeaker system. It offers substantial power and efficiency for a variety of professional applications that include portable systems, sound reinforcement, permanent installations and supplementary fill for larger systems. The high-frequency section is a constant directivity CMD horn mathematically designed for Coverage Matching Design in relation to the woofer system, loaded on a neodymium compression driver with a 2.5" diaphragm assembly for smooth, controlled dispersion. The low-frequency transducer is a tight, high power 10" mid-bass with a 2.5" voice coil.



### FEATURES

- 10" high power, 2.5" voice coil mid bass
- 1 x 2.5" high power titanium neo compression driver
- 130 dB max SPL
- 350 Watt AES
- High output, response down to 55 Hz
- Birch plywood cabinet
- Weather resistant, textured, polyurea finish
- Epoxy powder coated front grille

## TECHNICAL SPECIFICATIONS

<b>Acoustical specifications</b>	Frequency Response (-10dB):	55 Hz ÷ 20000 Hz
	Max SPL @ 1m:	130 dB
	Horizontal coverage angle:	90°
	Vertical coverage angle:	60°
	Directivity index Q:	10
	System Sensitivity:	98 dB
<b>Power section</b>	Nominal Impedance (ohm):	8 ohm
	Power Handling:	350 W RMS
	Peak Power Handling:	1400 W PEAK
	Recommended Amplifier:	700 W
	Protections:	Bulb lamp dynamic
	Crossover Frequencies:	1400 Hz
<b>Transducers</b>	Compression Driver:	1.4" neo, 2.5" v.c
	Nominal Impedance (ohm):	8 ohm
	Input Power Rating:	90 W AES, 180 W PEAK
	Sensitivity:	98 dB, 1W @ 1m
	Woofer:	10", 2.5" v.c
	Nominal Impedance (ohm):	8 ohm
	Input Power Rating:	250 W AES, 500 W PEAK
Sensitivity:	110 dB, 1W @ 1m	
<b>Input/Output section</b>	Input connectors:	Speakon® NL4
	Output connectors:	Speakon® NL4
<b>Standard compliance</b>	CE marking:	Yes
<b>Physical specifications</b>	Cabinet/Case Material:	Baltic birch plywood
	Hardware:	13 x M10 inserts
	Pole mount/Cap:	Yes
	Grille:	Steel
	Color:	Black
<b>Size</b>	Height:	540 mm / 21.26 inches
	Width:	340 mm / 13.39 inches
	Depth:	333 mm / 13.11 inches
	Weight:	17.7 kg / 39.02 lbs
<b>Shipping informations</b>	Package Height:	585 mm / 23.03 inches
	Package Width:	367 mm / 14.45 inches
	Package Depth:	372 mm / 14.65 inches
	Package Weight:	20.5 kg / 45.19 lbs



**PART NUMBER**

- **13000438**

V 10

EAN 8024530012854

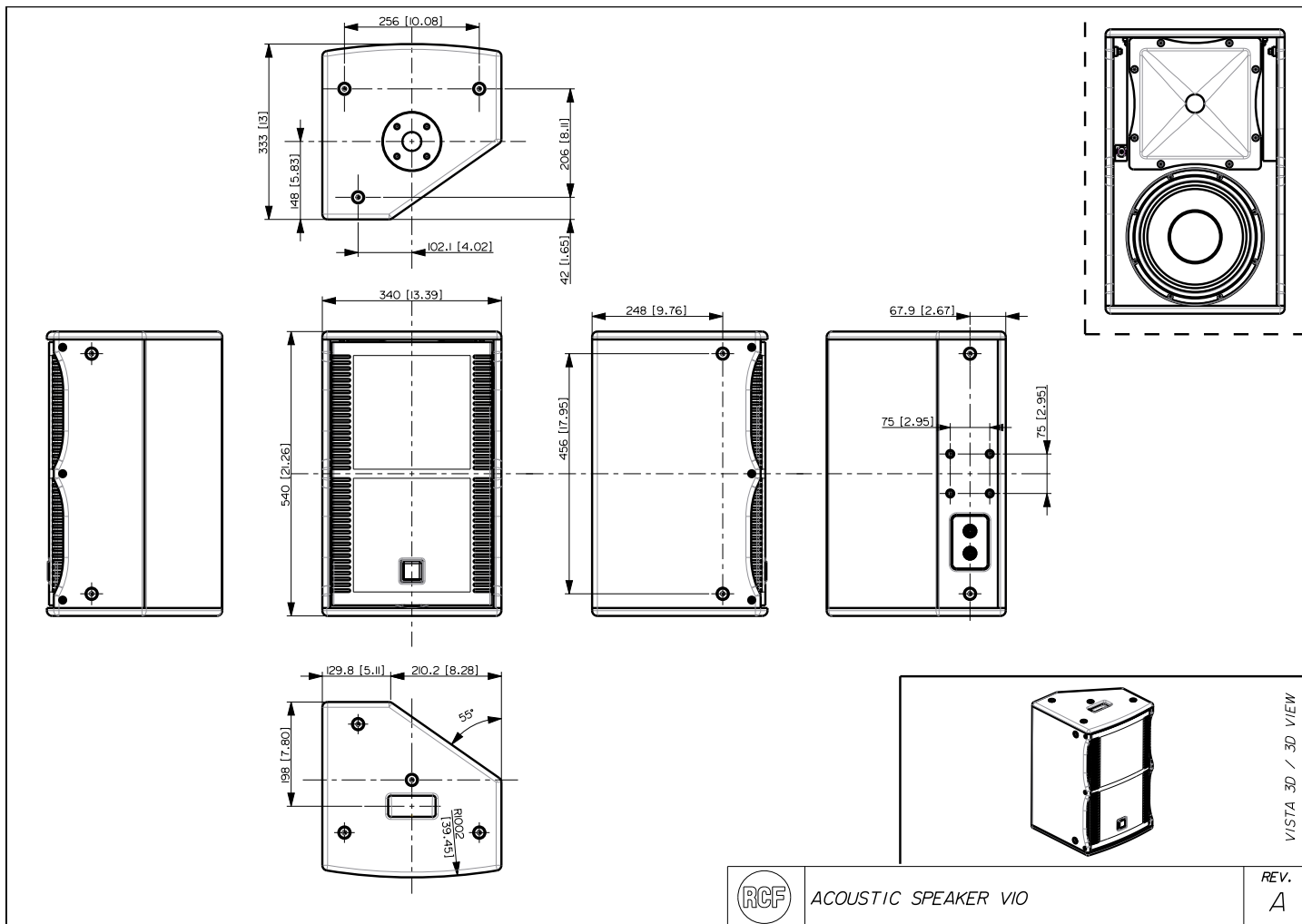

ACOUSTIC SPEAKER V10

REV.  
A

VISTA 3D / 3D VIEW

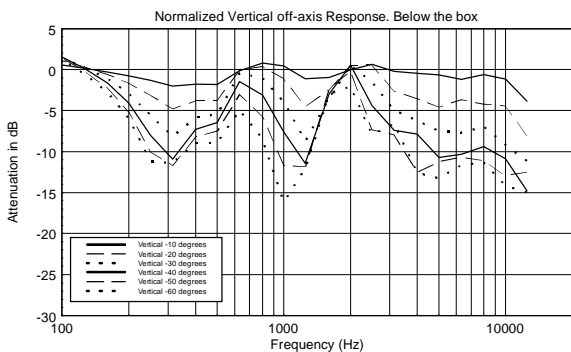
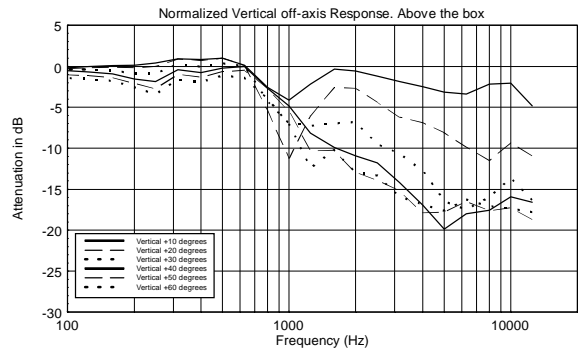
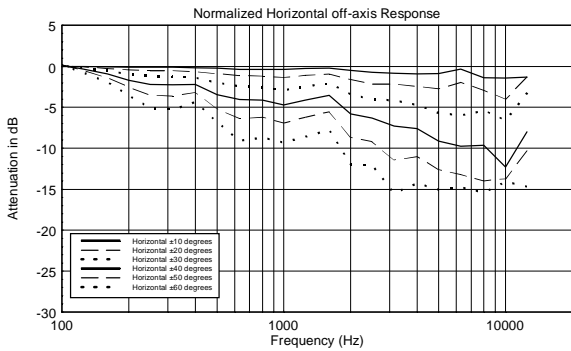
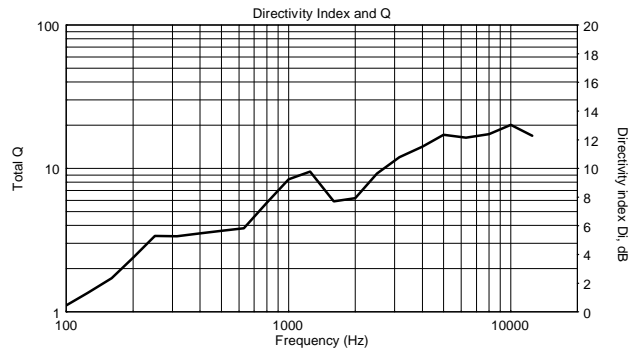
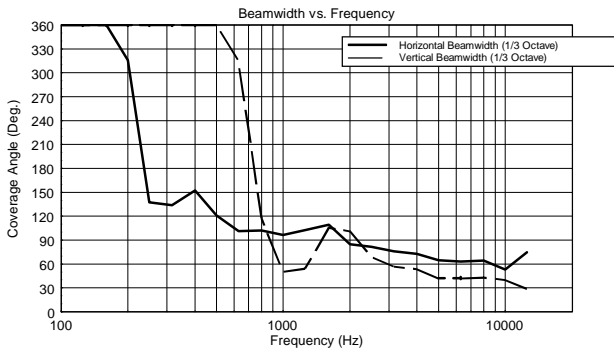
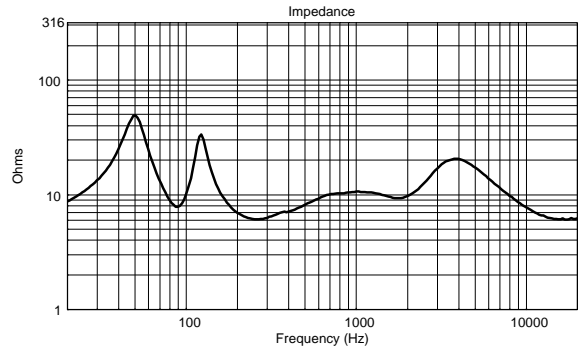
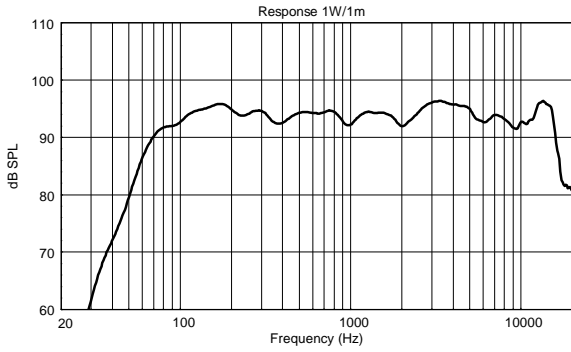

Horizontal 1/3 Octave Polars

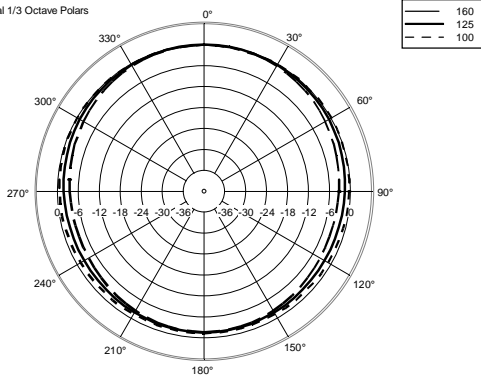

Horizontal 1/3 Octave Polars

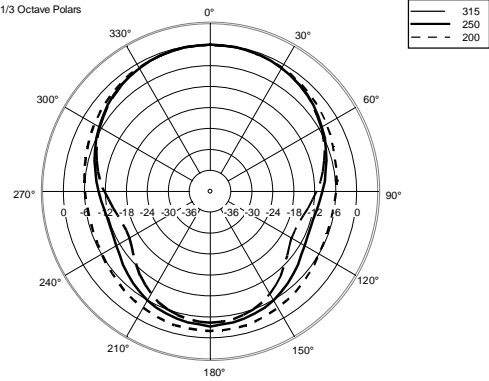

Horizontal 1/3 Octave Polars

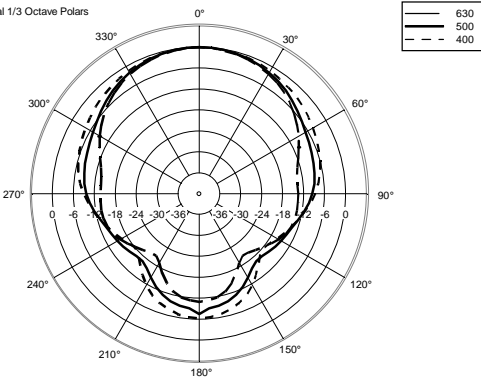

Horizontal 1/3 Octave Polars

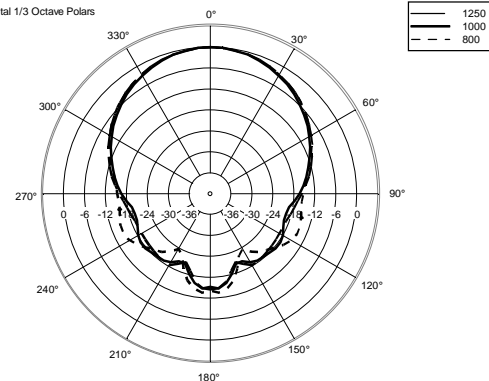

Horizontal 1/3 Octave Polars

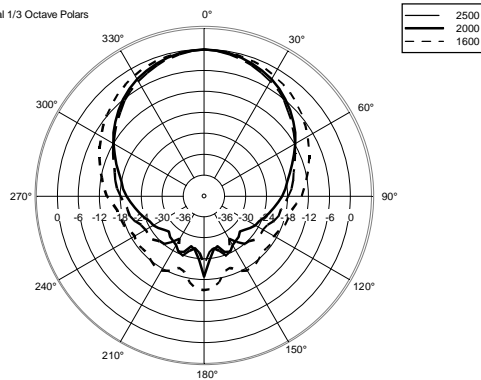

Horizontal 1/3 Octave Polars

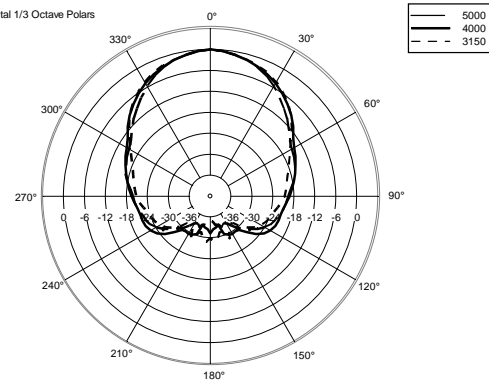

Horizontal 1/3 Octave Polars

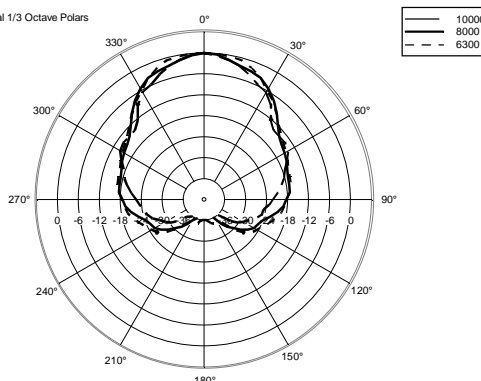

Horizontal One Octave Polars

