

# TTL 4-A

## ACTIVE TWO-WAY ARRAY SPEAKER

### DESCRIPTION

The TTL 4-A speaker module delivers top-quality sound for highly demanding events indoors or outdoors on small to medium-sized areas. Its design provides the audio engineer with the best tonal balance and intelligibility while maintaining an unobtrusive and adaptable footprint. With all the advantages of TT+ technology, such as high directivity, long-range, power, and precision, it's designed for professional applications.



### FEATURES

- 135 dB max SPL
- 100° x 25° coverage
- LF 2 x 10" neodymium woofer, 3.0" voice coil
- HF 1.5" Nd comp. driver 4.0" voice coil
- 2 x Class-D amplifiers, 1600 Watt RMS total power
- 45 - 20.000 Hz frequency range
- RDNet on board
- FiRPHASE 0° linear phase

## TECHNICAL SPECIFICATIONS

<b>Acoustical specifications</b>	Frequency Response:	45 Hz ÷ 20000 Hz
	Max SPL @ 1m:	135 dB
	Horizontal coverage angle:	100°
	Vertical coverage angle:	25°
<b>Transducers</b>	Compression Driver:	1 x 1.5" neo, 4.0" v.c
	Woofers:	2 x 10" neo, 3.0" v.c
<b>Input/Output section</b>	Input signal:	bal/unbal
	Input connectors:	XLR, RDNet Ethercon
	Output connectors:	XLR, RDNet Ethercon
	Input sensitivity:	+4 dBu
<b>Processor section</b>	Crossover Frequencies:	900Hz
	Protections:	Thermal, RMS
	Limiter:	Fast Limiter
	Controls:	Selectable preset, volume, delay
	RDNet:	Yes
<b>Power section</b>	Total Power:	3200 W Peak, 1600 W RMS
	High frequencies:	1200 W Peak, 600 W RMS
	Low frequencies:	2000 W Peak, 1000 W RMS
	Cooling:	Convection
	Connections:	Powercon IN/OUT
<b>Standard compliance</b>	CE marking:	Yes
<b>Physical specifications</b>	Cabinet/Case Material:	Baltic birch plywood
	Hardware:	Array fittings, 2xM10 on the top, 2xM8
	Handles:	2 side, 2 rear
	Pole mount/Cap:	Yes
	Grille:	Steel
	Color:	Black
<b>Size</b>	Height:	825 mm / 32.48 inches
	Width:	316 mm / 12.44 inches
	Depth:	369 mm / 14.53 inches
	Weight:	30.4 kg / 67.02 lbs
<b>Shipping informations</b>	Package Height:	410 mm / 16.14 inches
	Package Width:	865 mm / 34.06 inches
	Package Depth:	365 mm / 14.37 inches
	Package Weight:	33.5 kg / 73.85 lbs



**PART NUMBER**

- **13000584**

TTL 4-A

EAN 8024530017576

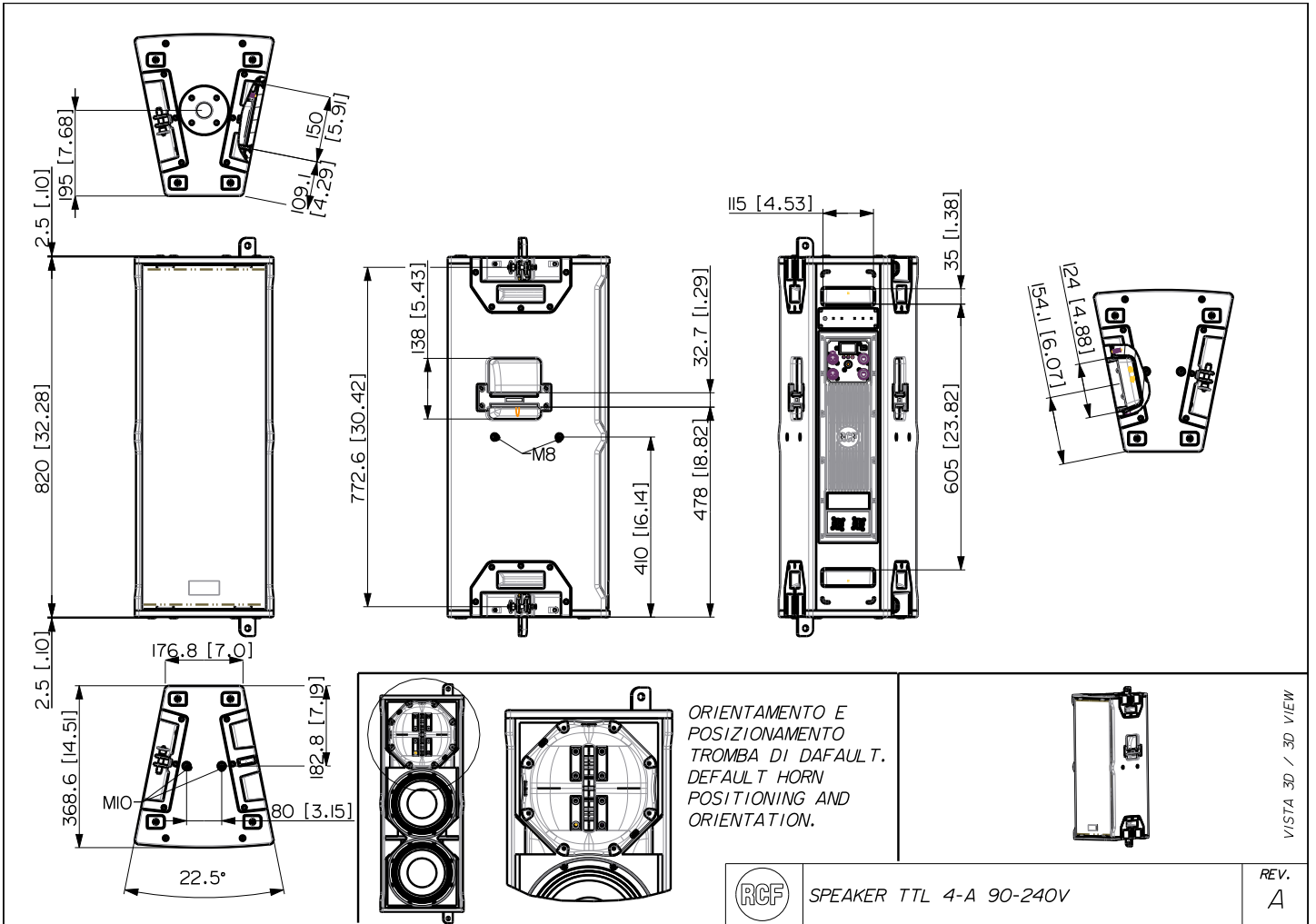

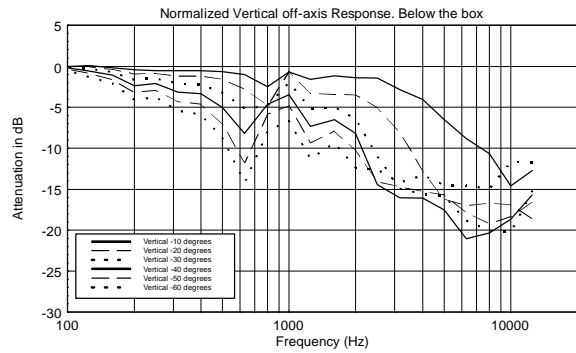
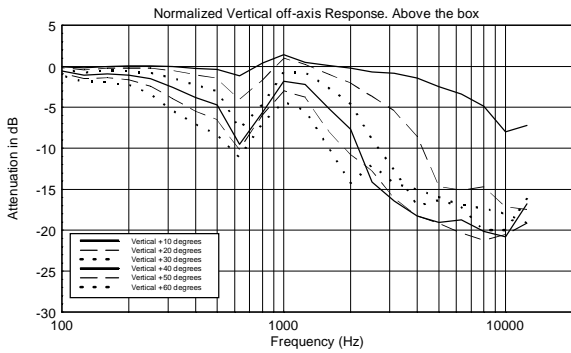
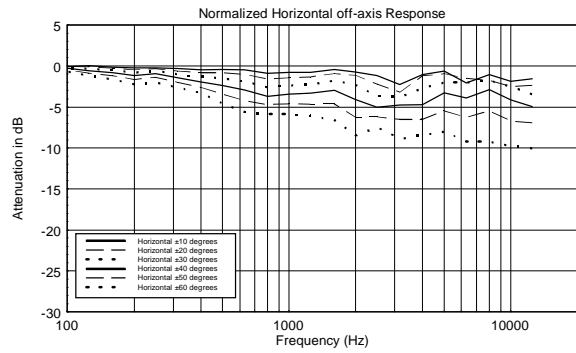
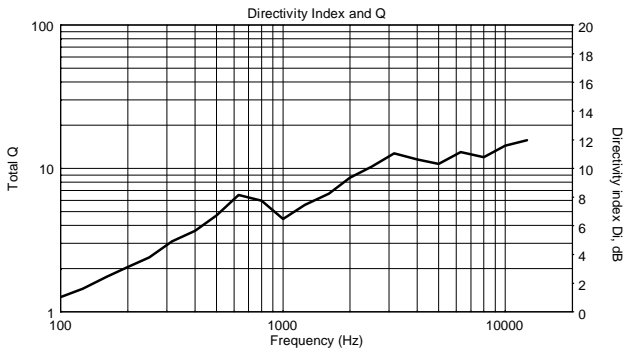
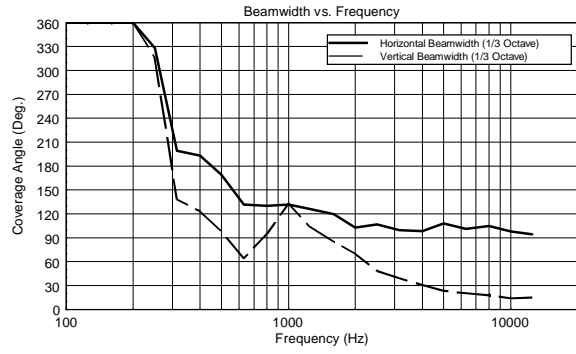
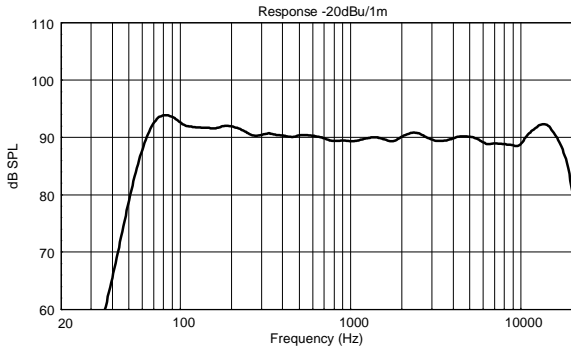

Horizontal 1/3 Octave Polars

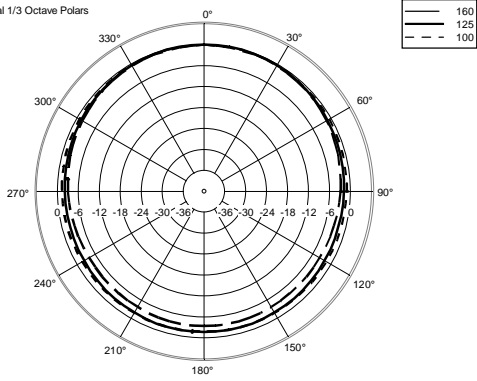

Horizontal 1/3 Octave Polars

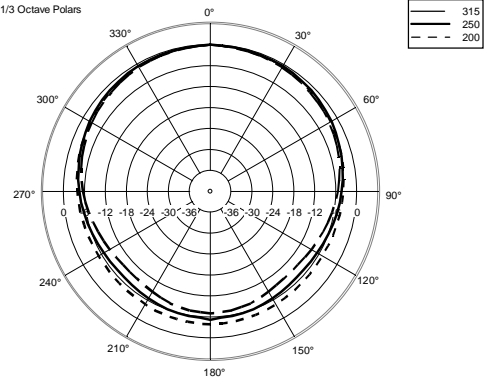

Horizontal 1/3 Octave Polars

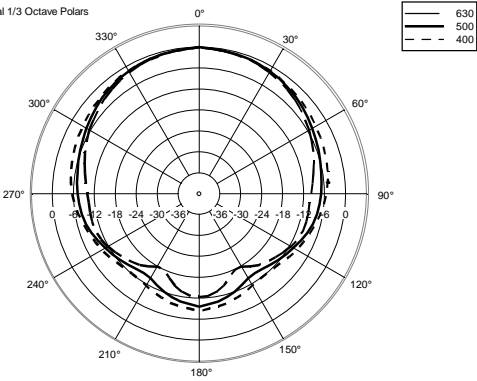

Horizontal 1/3 Octave Polars

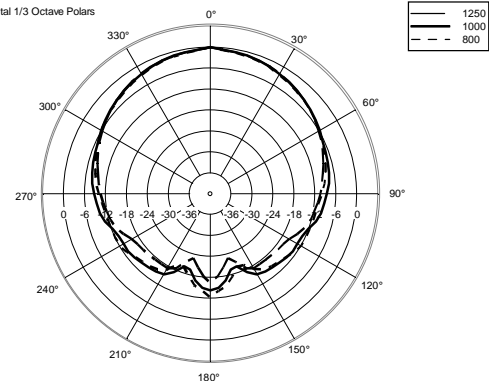

Horizontal 1/3 Octave Polars

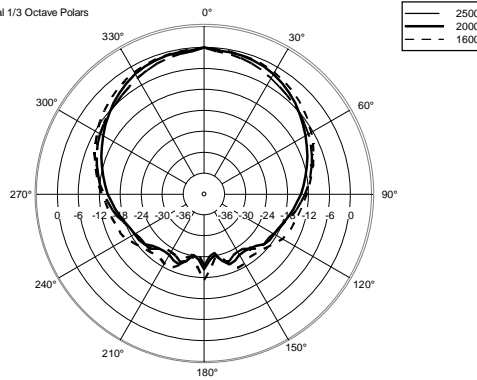

Horizontal 1/3 Octave Polars

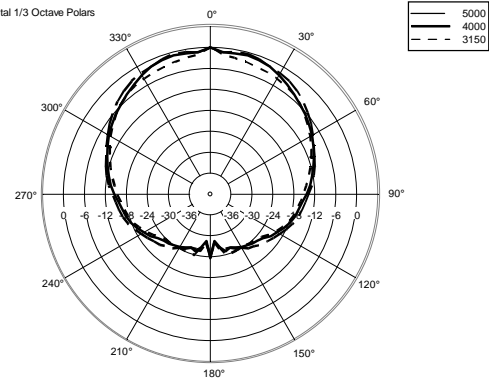

Horizontal 1/3 Octave Polars

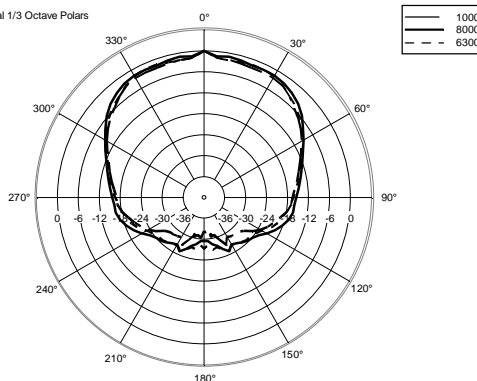



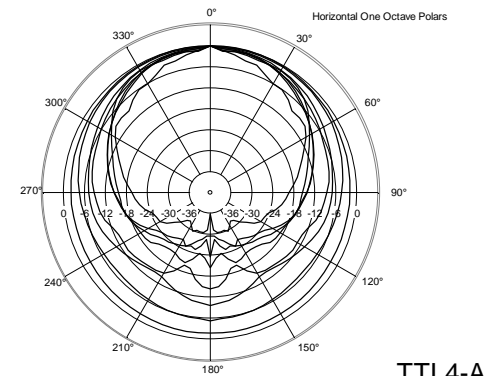

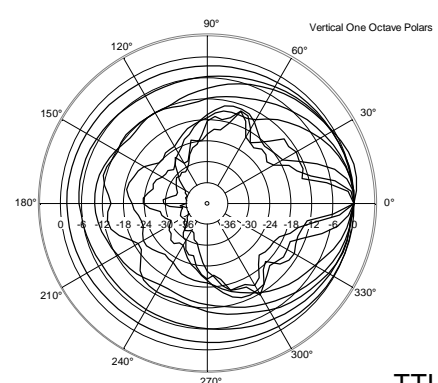
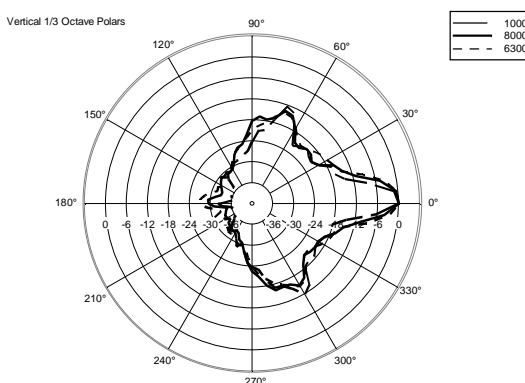
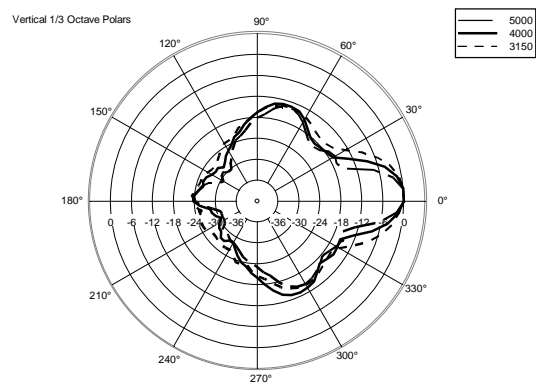
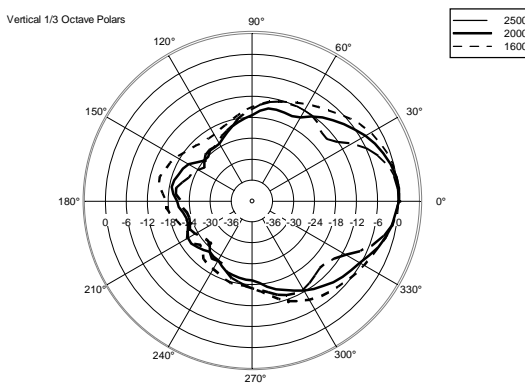
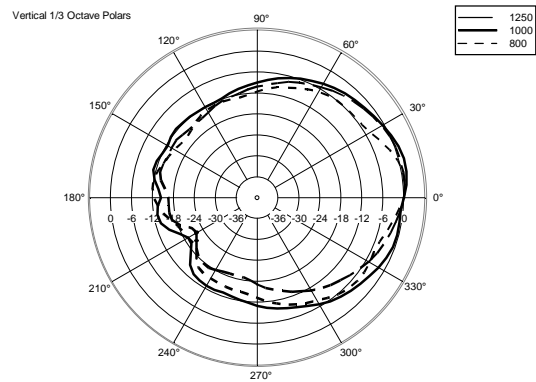
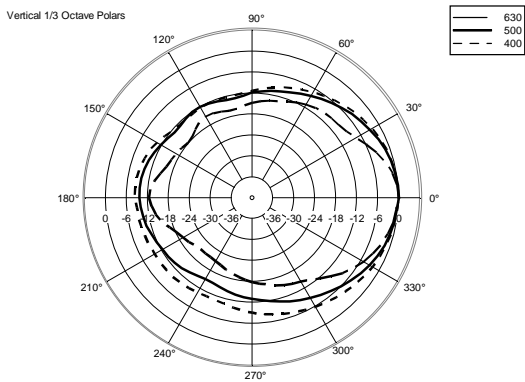
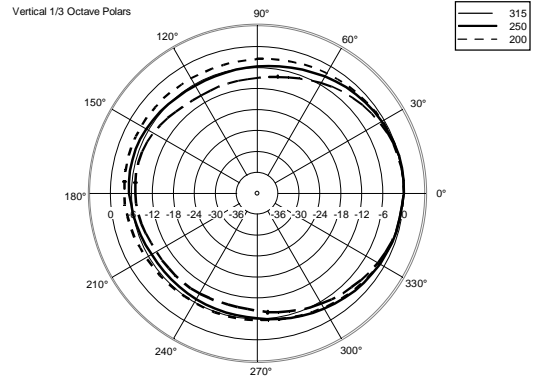
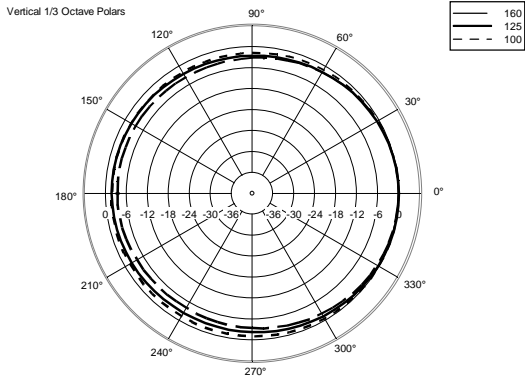



Horizontal One Octave Polars





**ACCESSORIES**

	AC PMA - POLE MOUNT	PART NUMBER EAN:	<b>13360034</b> 8024530007713
	AC PMX POLE MOUNT M20	PART NUMBER EAN:	<b>13360232</b> 8024530010058
	AC PRO-FS PROFESS. LOCKING FLOOR STAND	PART NUMBER EAN:	<b>13360109</b> 8024530006471
	AC PRO-PM PROFESS. LOCKING POLE MOUNT	PART NUMBER EAN:	<b>13360110</b> 8024530006488
	CABLES KIT CBL ETHERCON 0.7M	PART NUMBER EAN:	<b>12399016</b> 8024530013844
	CABLES KIT CBL ETHERCON 1.5M	PART NUMBER EAN:	<b>12399017</b> 8024530013851
	CABLES KIT CBL ETHERCON 3M	PART NUMBER EAN:	<b>12399035</b> 8024530013868
	CABLES KIT CBL ETHERCON 5M	PART NUMBER EAN:	<b>12399018</b> 8024530013875
	CABLES KIT CBL ETHERCON TO XLR F 0.2M	PART NUMBER EAN:	<b>12399019</b> 8024530013882





CABLES KIT CBL ETHERCON TO XLR M 0.2M

PART NUMBER **12399020**  
EAN: 8024530013899



CABLES KIT CBL POWERCON LINK 0.7M

PART NUMBER **12399031**  
EAN: 8024530013738



CABLES KIT CBL POWERCON LINK 1.5M

PART NUMBER **12399030**  
EAN: 8024530013721



COVER CVR TT 4

PART NUMBER **13360440**  
EAN: 8024530017583



FLY BAR FL-B H TT 4

PART NUMBER **13360425**  
EAN:



FLY BAR FL-B V TT 4

PART NUMBER **13360423**  
EAN: 8024530017668



LINK BAR FL-B LINK TT 4

PART NUMBER **13360428**  
EAN: 8024530017620

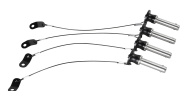

QUICK LOCK PIN QL-PIN D11.2 L31 4X

PART NUMBER **13360335**  
EAN: 8024530013257



RAIN PROTECTION RP 1X HDL 30

PART NUMBER **13360388**  
EAN: 8024530015138



VERTICAL BRACKET V-BR TT 4

PART NUMBER **13360427**  
EAN: 8024530017637

