

# P 6215

## WEATHERPROOF COAXIAL TWO WAY SPEAKER

### DESCRIPTION

The P6215 is a weatherproof full range, wide-dispersion, coaxial two way loudspeaker system for very high output and longer throw applications.

The high-frequency section is a constant directivity CMD horn loaded to a 1.3" RCF Precision compression driver with a 2.5" diaphragm assembly for smooth, wide dispersion. The low frequency transducer is a 15" woofer with a 3" voice coil. The cabinet is equipped with 12 x M10 brass inserts, a stainless steel U-Bracket and pair of spacers for 90° mounting. P6215 meets the requirements of IP 55 code (International Protection Rating)



### FEATURES

- Cabinet is a single piece rotational moulded in medium density polyethylene, fully UV protected and waterproof IP 55
- Front grille in custom perforated aluminium with open-cell fibres and water repellent woven fabric backing
- Stainless steel bracket
- One 15" high-output LF transducer with 3" voice coil
- One RCF Precision 1.3" C. Driver with 2.5" voice coil
- 60° x 60° conical horn
- 10° X 20° enclosure sides for array configurations
- Active Mosfet Compression Driver Protection
- 12 brass suspension points (M10)
- Line transformer

## TECHNICAL SPECIFICATIONS

<b>Acoustical specifications</b>	Frequency Response (-10dB):	75 Hz ÷ 20000 Hz
	Max SPL @ 1m:	134 dB
	Horizontal coverage angle:	60°
	Vertical coverage angle:	60°
	Directivity index Q:	13
	System Sensitivity:	100 dB
<b>Power section</b>	Nominal Impedance (ohm):	8 ohm
	Power Handling:	600 W RMS
	Peak Power Handling:	2400 W PEAK
	Recommended Amplifier:	1200 W
	Protections:	Dynamic active mosfet
	Crossover Frequencies:	1100 Hz
<b>Transducers</b>	Compression Driver:	Coaxial 1.3" neo, 2.5" v.c
	Nominal Impedance (ohm):	8 ohm
	Input Power Rating:	90 W AES, 180 W PEAK
	Sensitivity:	108 dB, 1W @ 1m
	Woofer:	Coaxial 15" neo, 3.0" v.c
	Nominal Impedance (ohm):	8 ohm
	Input Power Rating:	450 W AES, 900 W PEAK
Sensitivity:	101 dB, 1W @ 1m	
<b>Input/Output section</b>	Input connectors:	Neoprene Cable
<b>Standard compliance</b>	IP protection grade:	IP 55
	CE marking:	Yes
<b>Physical specifications</b>	Cabinet/Case Material:	PE Low Density
	Hardware:	12 x M10 + U-Bracket and Pair of spacers
	Grille:	Aluminum with waterproof clothing
	Color:	Grey
<b>Size</b>	Height:	463 mm / 18.23 inches
	Width:	463 mm / 18.23 inches
	Depth:	433 mm / 17.05 inches
	Weight:	17 kg / 37.48 lbs
<b>Shipping informations</b>	Package Height:	519 mm / 20.43 inches
	Package Width:	489 mm / 19.25 inches
	Package Depth:	489 mm / 19.25 inches
	Package Weight:	21.4 kg / 47.18 lbs



**PART NUMBER**

- **13100083**

P 6215 W

- **13000131**

P 6215

EAN 8024530008260

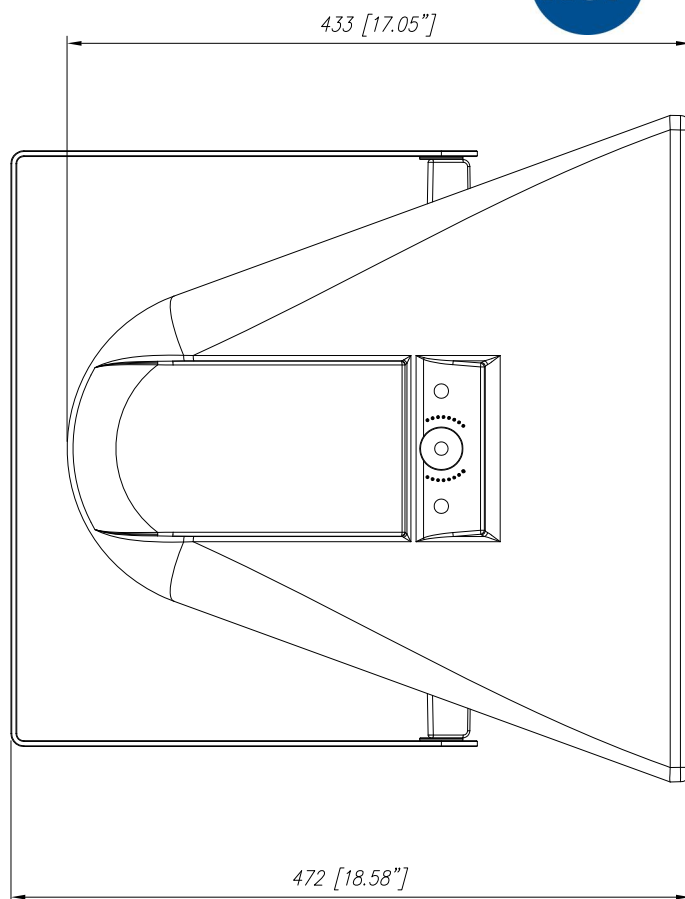
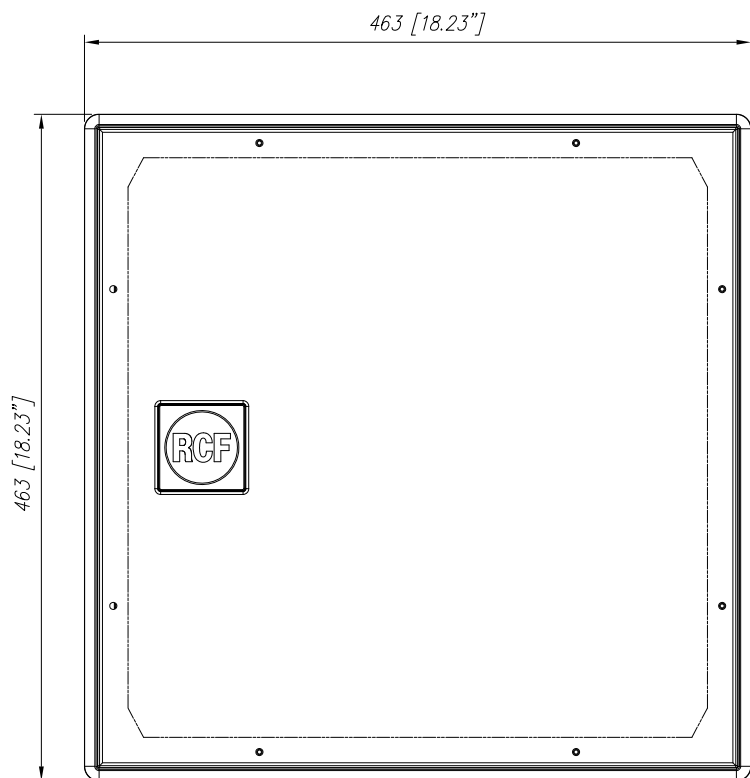

P3115

P6215

P8015

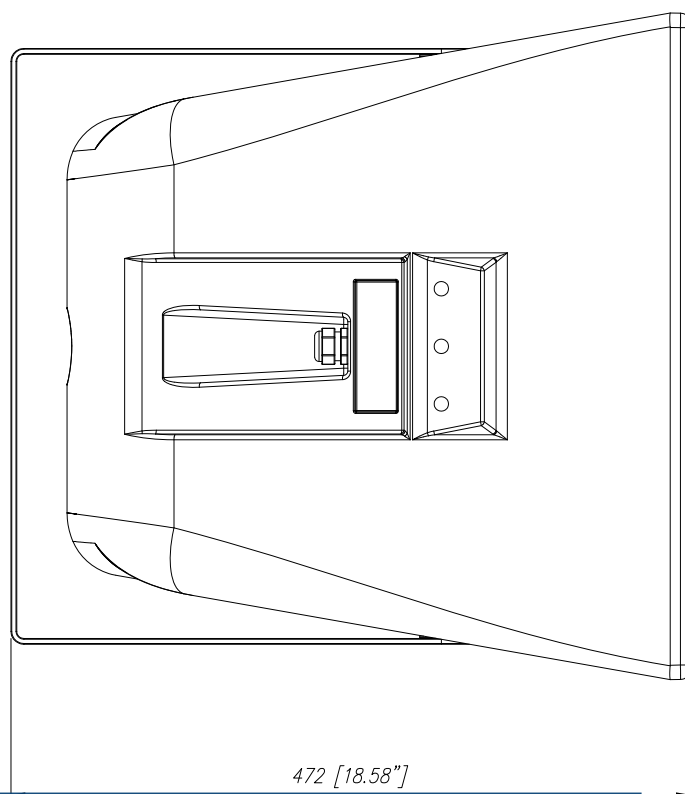

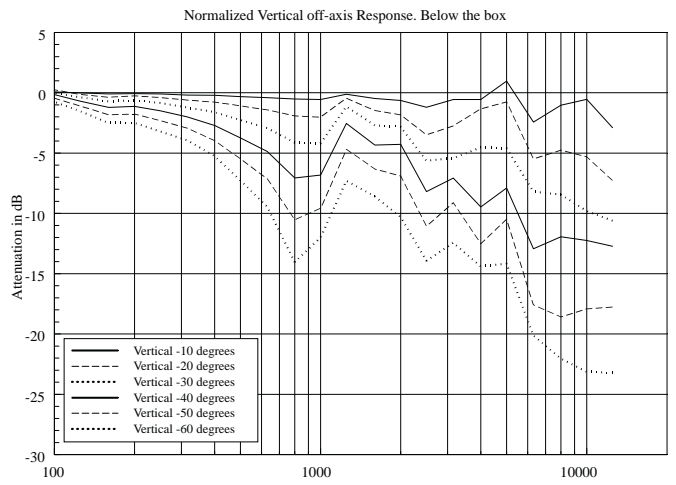
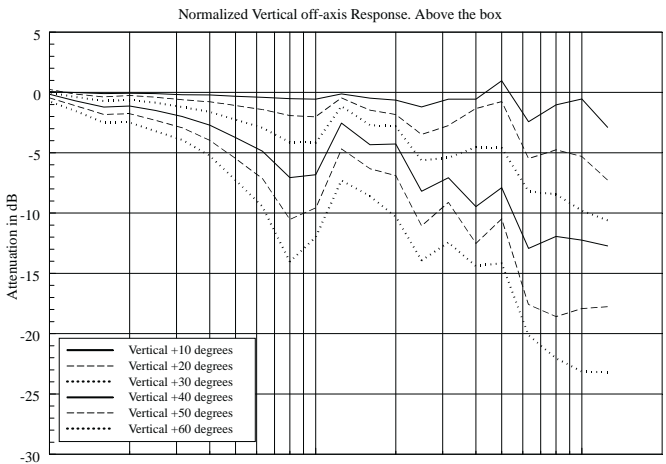
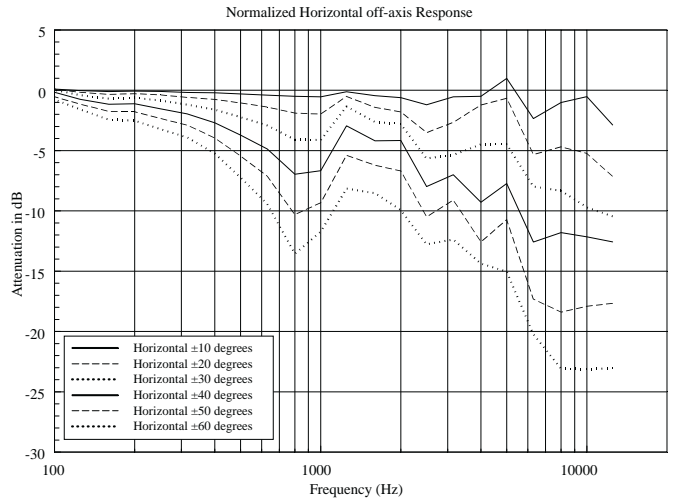
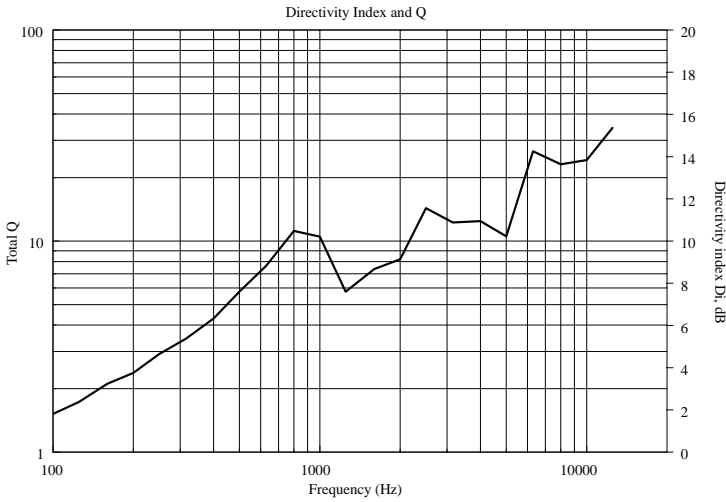
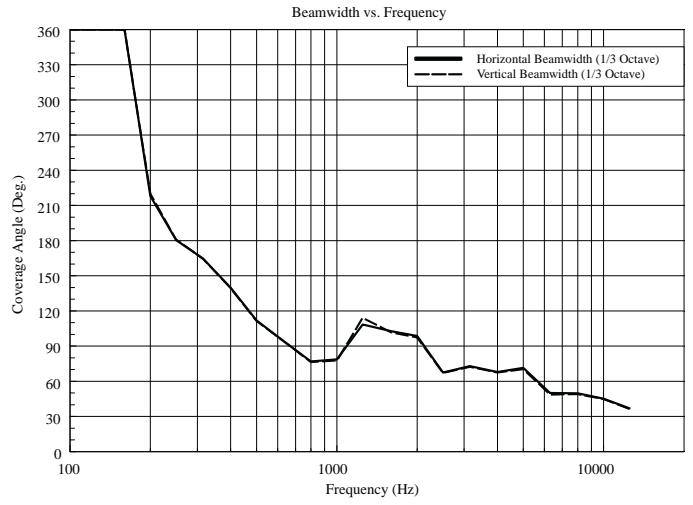
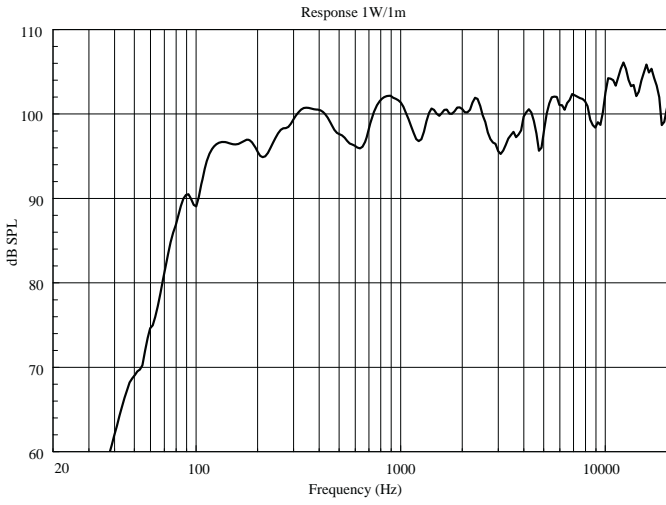

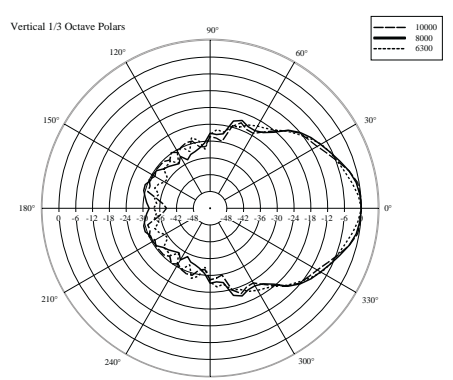
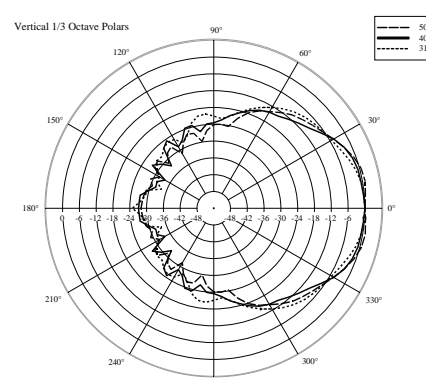
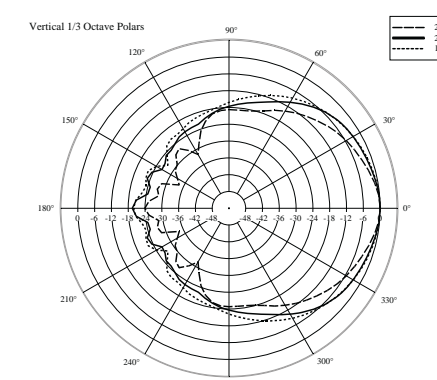
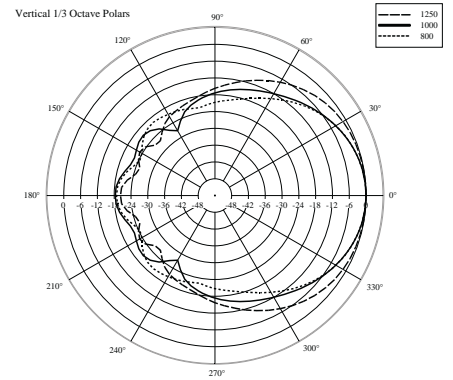
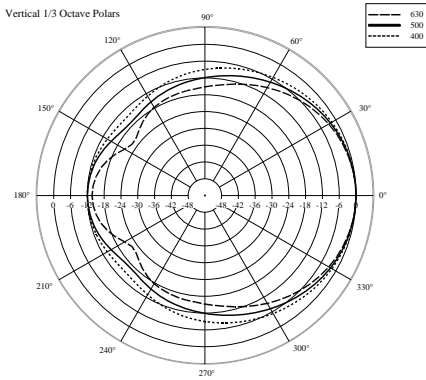
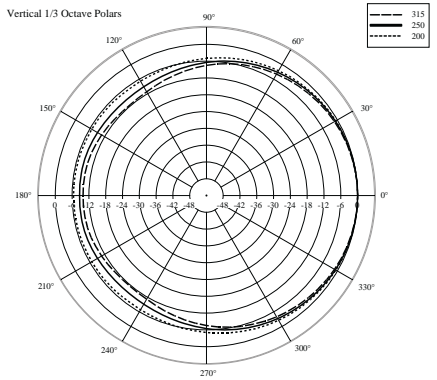
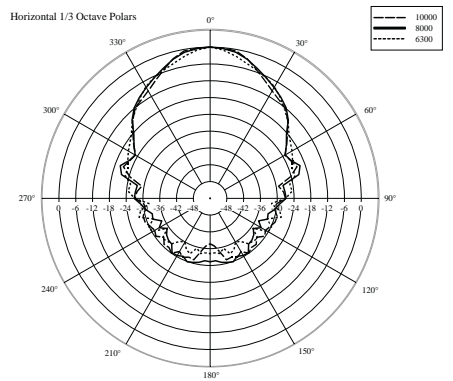
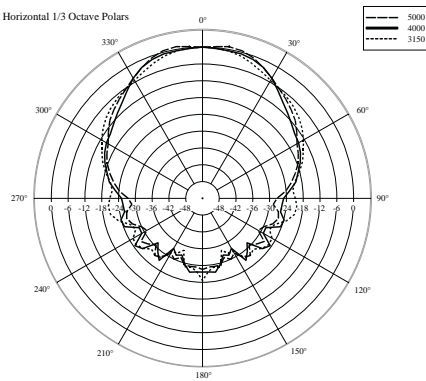
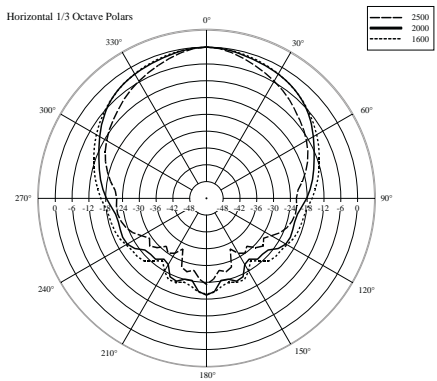
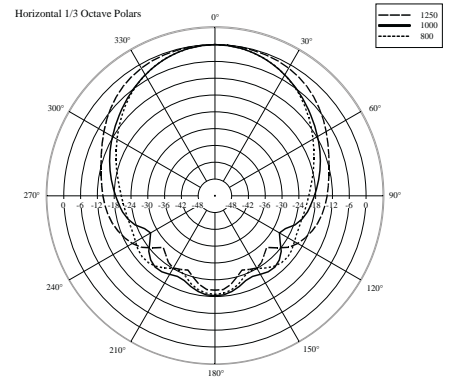
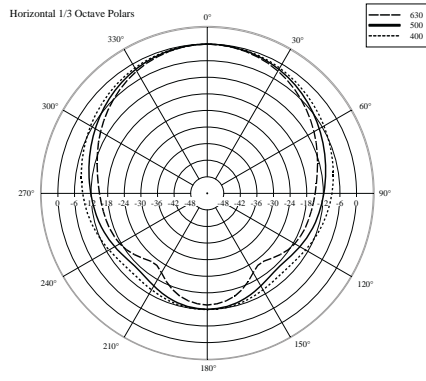
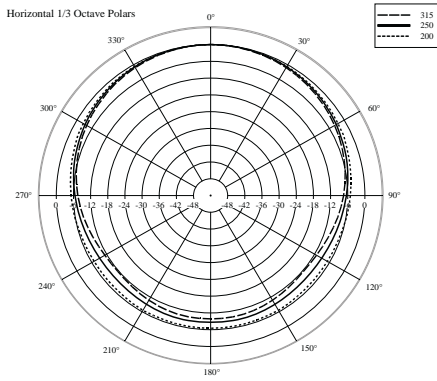

**ACCESSORIES**



AC P15 A-BR CLUSTER BRACK.- P6215/P3115

PART NUMBER **13360094**  
EAN: 8024530006105

---