

# NXL 44-A

## ACTIVE TWO-WAY ARRAY

### DESCRIPTION

NXL 44-A is a line array column speaker featuring a two-channel 1,400 Watt amplifier powering three 10" neodymium woofers and a 1.4" driver with 3" voice coil on an asymmetrical waveguide. The horn's design delivers accurate sound to the coverage area without tilting the enclosure. The speaker delivers an extended frequency range down to 45 Hz, used alone or coupled with subwoofers for medium-sized concerts and DJ sets. Precision controlled by an on-board DSP, the NXL 44-A is ideal for professional live sound reinforcement with sleek design, incredible power, and sound detail. A complete set of rigging accessories allows for simple flying and stacking.



### FEATURES

- 1,400 WATT Class D Bi-Amplification
- 90° x 30° constant directivity waveguide, tilted (+5°, -25°)
- 3 x 10" neodymium woofer
- 1.4" compression neodymium driver, 3.0" voice coil
- DSP Processing with optimized phase response
- Easy-to-fly and install with built-in rigging points

## TECHNICAL SPECIFICATIONS

<b>Acoustical specifications</b>	Frequency Response:	45 Hz ÷ 20000 Hz
	Max SPL @ 1m:	134 dB
	Horizontal coverage angle:	90°
	Vertical coverage angle:	30°
<b>Transducers</b>	Compression Driver:	1 x 1.4" neo, 3.0" v.c
	Woofers:	3 x 10" neo, 2.5" v.c
<b>Input/Output section</b>	Input signal:	bal/unbal
	Input connectors:	XLR, Jack
	Output connectors:	XLR
	Input sensitivity:	-2 dBu/+4 dBu
<b>Processor section</b>	Crossover Frequencies:	800 Hz
	Protections:	Thermal, RMS
	Limiter:	Soft Limiter
	Controls:	Volume, EQ Shape, Mic/Line
<b>Power section</b>	Total Power:	1400 W Peak, 700 W RMS
	High frequencies:	400 W Peak, 200 W RMS
	Low frequencies:	1000 W Peak, 500 W RMS
	Cooling:	Convection
	Connections:	Powercon IN/OUT
<b>Standard compliance</b>	CE marking:	Yes
<b>Physical specifications</b>	Cabinet/Case Material:	Baltic birch plywood
	Hardware:	4 x M8, 4 x quick lock, 2 x pole mount
	Handles:	4 side
	Pole mount/Cap:	Yes
	Grille:	Steel
	Color:	Black
<b>Size</b>	Height:	1198 mm / 47.17 inches
	Width:	303 mm / 11.93 inches
	Depth:	402 mm / 15.83 inches
	Weight:	34.5 kg / 76.06 lbs
<b>Shipping informations</b>	Package Height:	437 mm / 17.2 inches
	Package Width:	1224 mm / 48.19 inches
	Package Depth:	330 mm / 12.99 inches
	Package Weight:	36.5 kg / 80.47 lbs



**PART NUMBER**

• **13000480**

NXL 44-A

115V

EAN 8024530013660

• **13000479**

NXL 44-A

220-240V

EAN 8024530013523

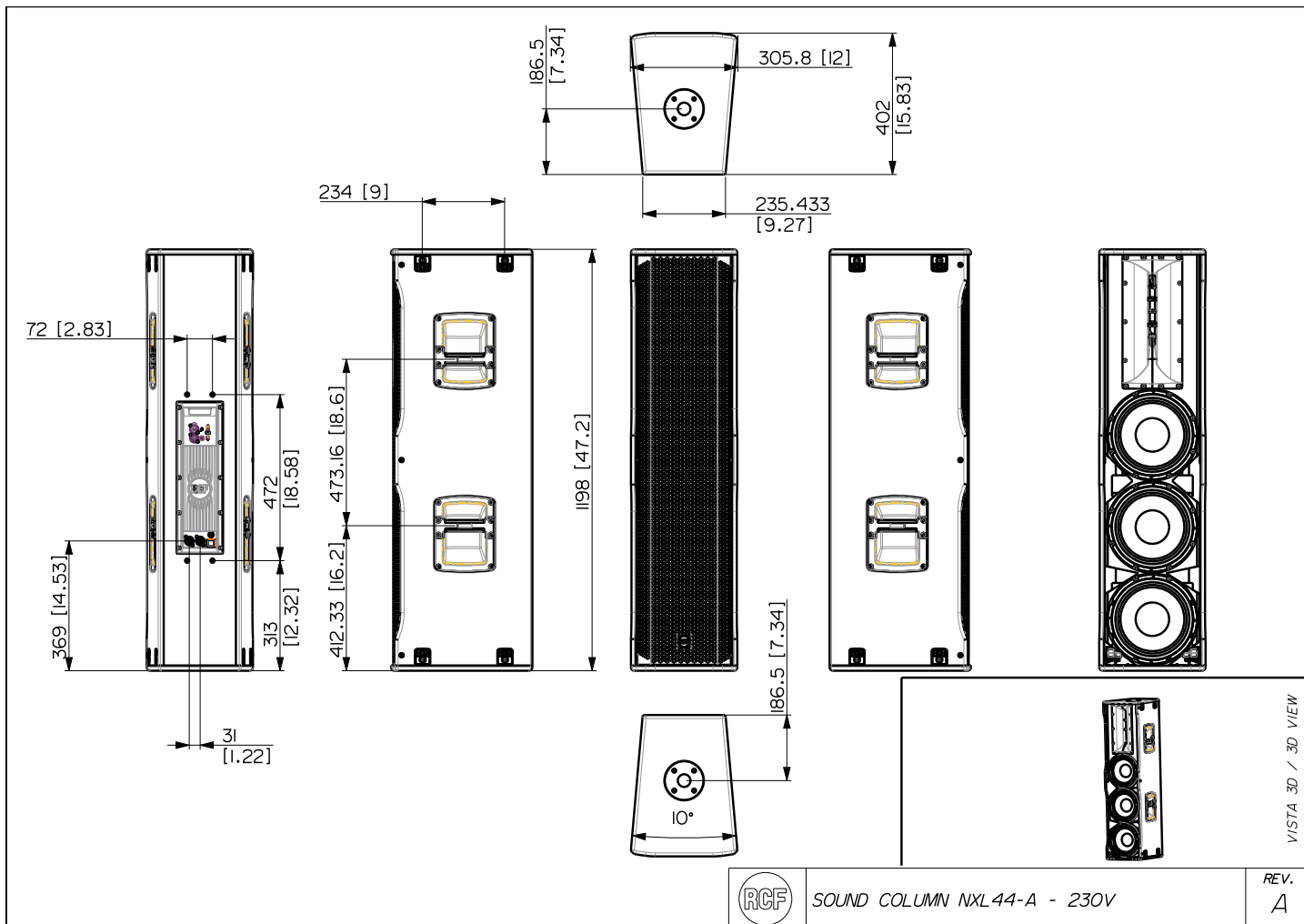

SOUND COLUMN NXL44-A - 230V

REV.  
A



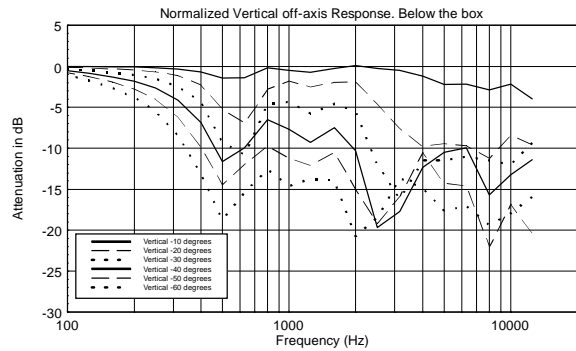
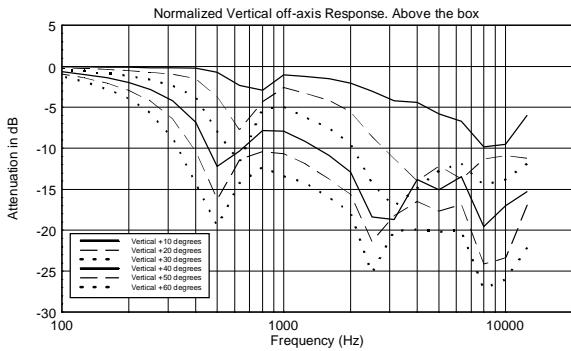
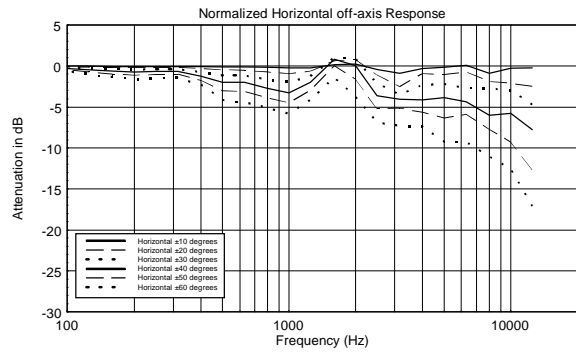
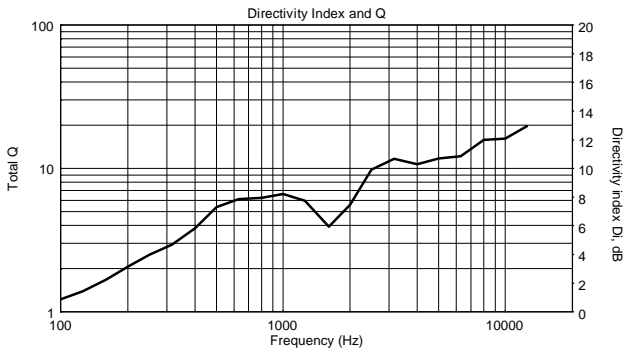
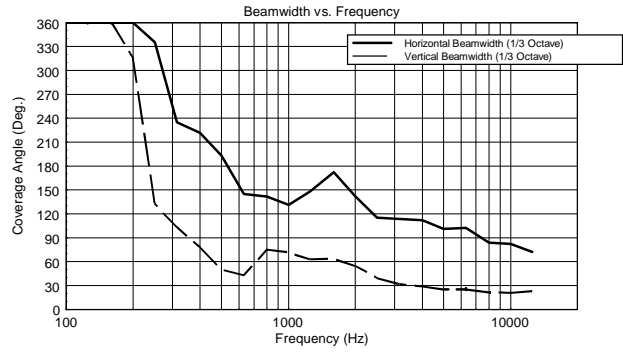
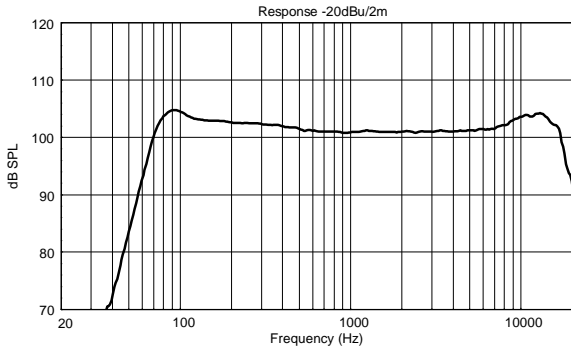

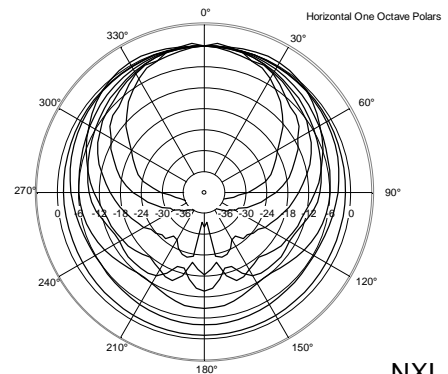
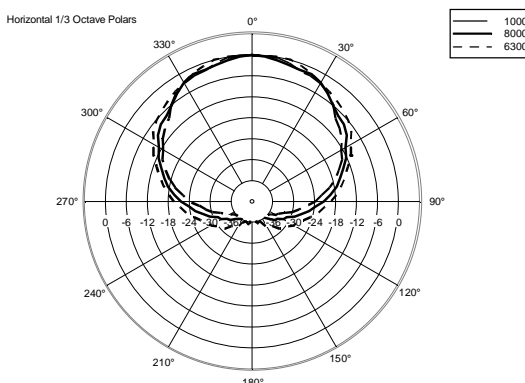
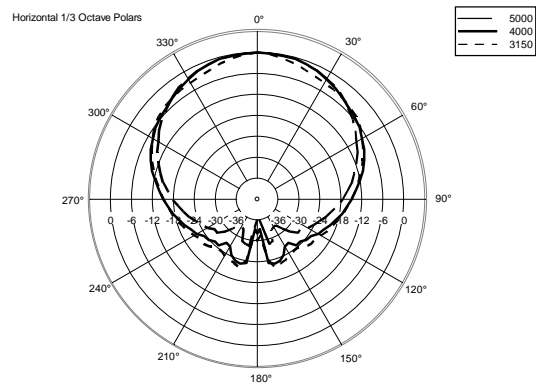
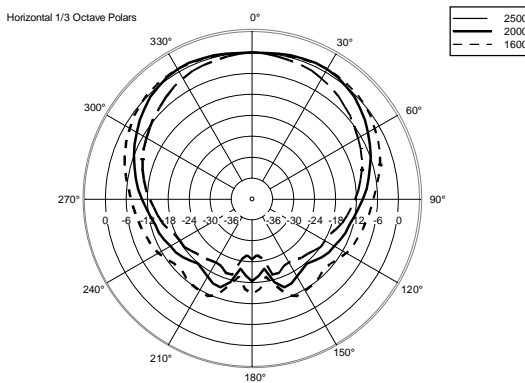
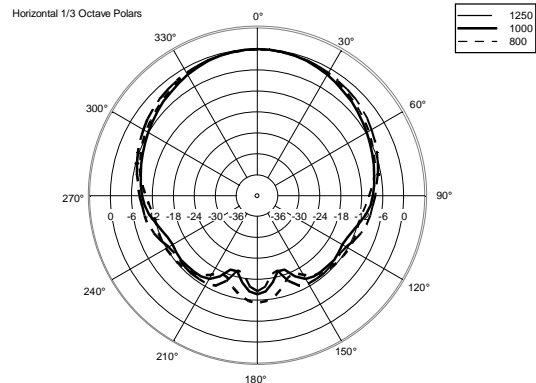
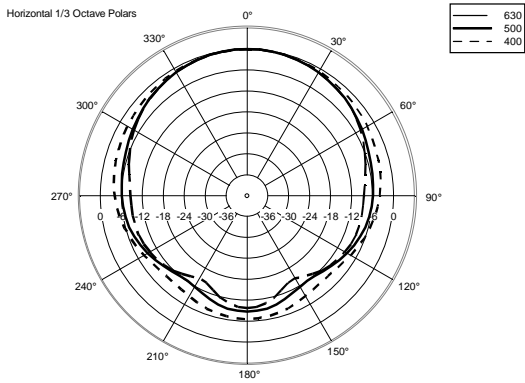
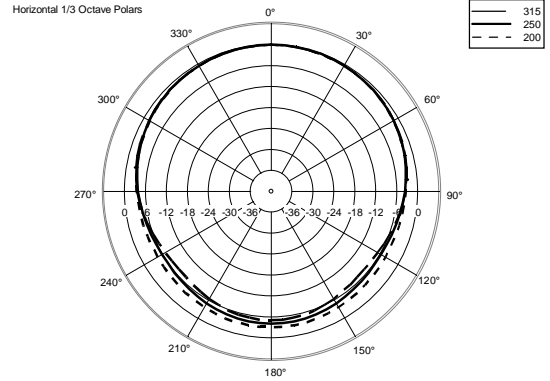
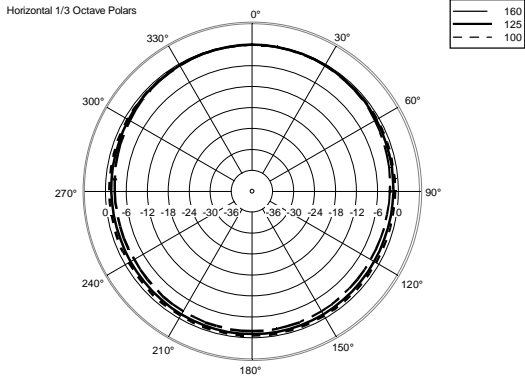

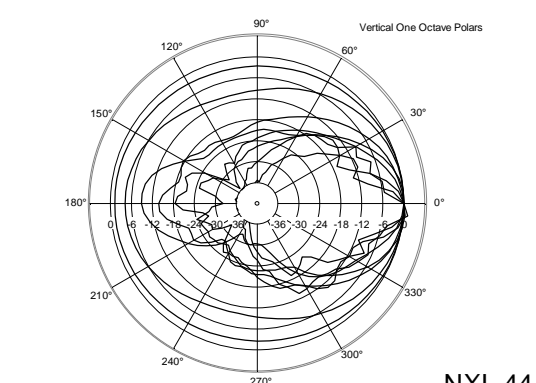
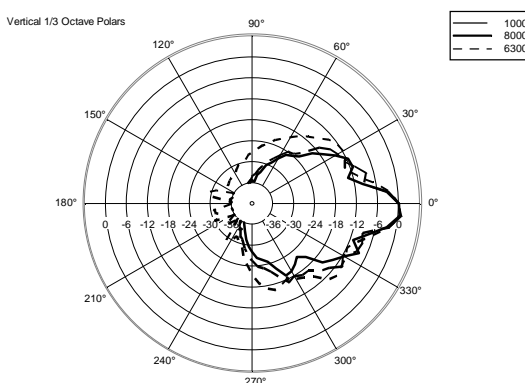
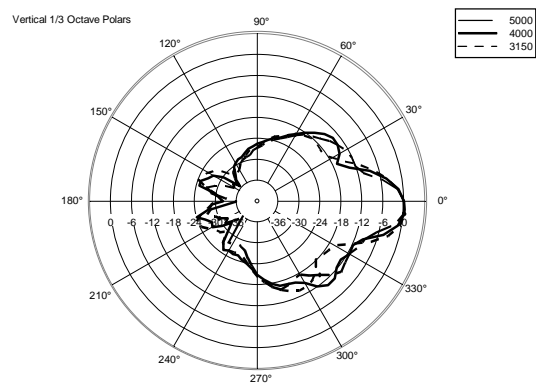
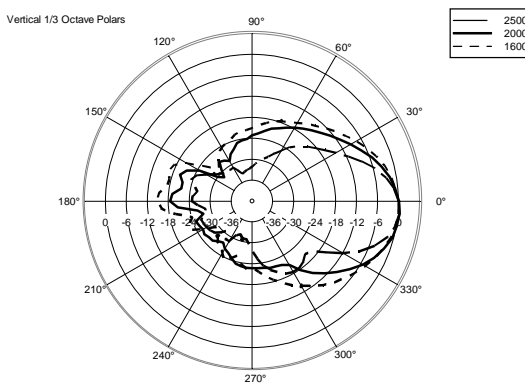
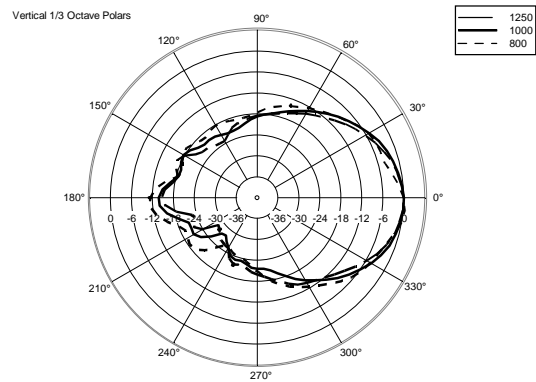
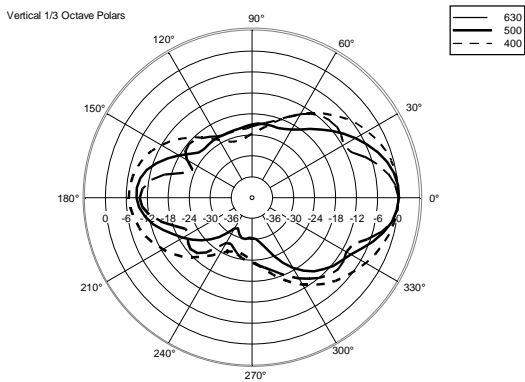
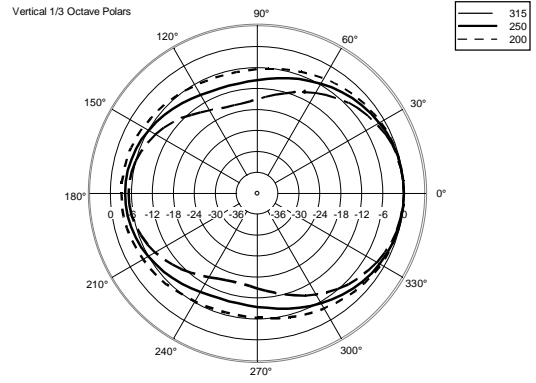
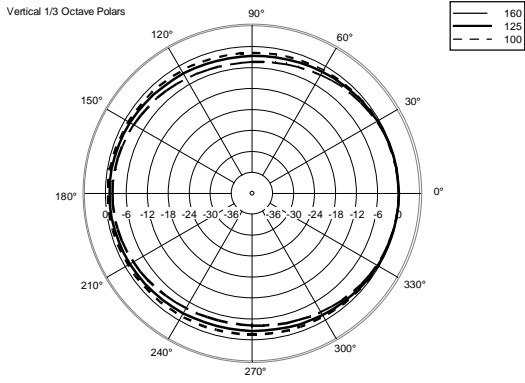

VISTA 3D / 3D VIEW







**ACCESSORIES**

	AC PMA - POLE MOUNT	PART NUMBER EAN:	<b>13360034</b> 8024530007713
	AC PM-M20	PART NUMBER EAN:	<b>13360067</b> 8024530014599
	AC PMX POLE MOUNT M20	PART NUMBER EAN:	<b>13360232</b> 8024530010058
	AC PRO-FS PROFESS. LOCKING FLOOR STAND	PART NUMBER EAN:	<b>13360109</b> 8024530006471
	AC PRO-PM PROFESS. LOCKING POLE MOUNT	PART NUMBER EAN:	<b>13360110</b> 8024530006488
	FLY BAR FL-B NXL 44	PART NUMBER EAN:	<b>13360345</b> 8024530013653
	LINK BAR FL-B LINK NXL 44	PART NUMBER EAN:	<b>13360346</b> 8024530013639
	STACKING KIT 2X NXL44-A	PART NUMBER EAN:	<b>13360347</b> 8024530013646