

NXL 24-A

ACTIVE TWO-WAY ARRAY

DESCRIPTION

The NXL 24-A is an active column speaker array system with four 6" high power woofers and a 2.5" voice coil compression driver loaded on a 100° x 30° constant directivity waveguide. The amplifier delivers 1,400 Watts and is controlled by a DSP handling crossover, equalization, phase alignment, soft limiting, and speaker protections. Equalization can be applied to a single unit or a pair of speakers.



FEATURES

- 1,400 Watt Class D bi-amplification
- 131 dB SPL Max
- 65 Hz - 20 kHz frequency response
- 4 x 6" Woofers
- 2.5" voice coil RCF Precision C. Driver on a waveguide
- 100° x 30° slightly tilted pattern control
- DSP controlled input section with single or dual EQ preset
- East-to-fly and install with built-in rigging points and pole mount socket

TECHNICAL SPECIFICATIONS

Acoustical specifications	Frequency Response:	65 Hz ÷ 20000 Hz
	Max SPL @ 1m:	131 dB
	Horizontal coverage angle:	100°
	Vertical coverage angle:	30°
Transducers	Compression Driver:	1.4", 2.5" v.c
	Woofers:	4 x 6.0", 1.5" v.c
Input/Output section	Input signal:	bal/unbal
	Input connectors:	XRL, Jack
	Output connectors:	XLR
	Input sensitivity:	-2 dBu/+4 dBu
Processor section	Crossover Frequencies:	800 Hz
	Protections:	Thermal, RMS
	Limiter:	Soft Limiter
	Controls:	Volume, EQ Shape, Mlc/Line
Power section	Total Power:	1400 W Peak, 700 W RMS
	Low frequencies:	1000 W Peak, 500 W RMS
	Cooling:	Convection
	Connections:	Powercon IN/OUT
Standard compliance	CE marking:	Yes
Physical specifications	Cabinet/Case Material:	Baltic birch plywood
	Hardware:	4 x MB, 4 x quick lock
	Handles:	2 side
	Pole mount/Cap:	Yes
	Grille:	Steel
	Color:	Black
Size	Height:	1056 mm / 41.57 inches
	Width:	201 mm / 7.91 inches
	Depth:	274 mm / 10.79 inches
	Weight:	26.4 kg / 58.2 lbs
Shipping informations	Package Height:	316 mm / 12.44 inches
	Package Width:	1155 mm / 45.47 inches
	Package Depth:	222 mm / 8.74 inches
	Package Weight:	29 kg / 63.93 lbs



PART NUMBER

• **13000400**

NXL 24-A

115V

EAN 8024530010812

• **13000399**

NXL 24-A

220-240V

EAN 8024530010805

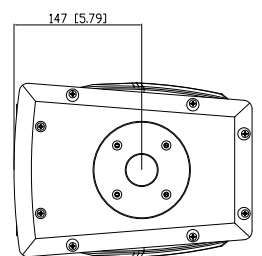
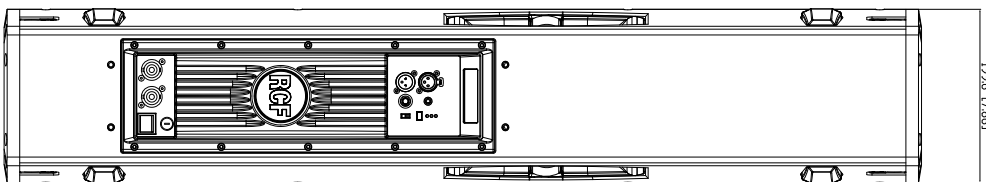
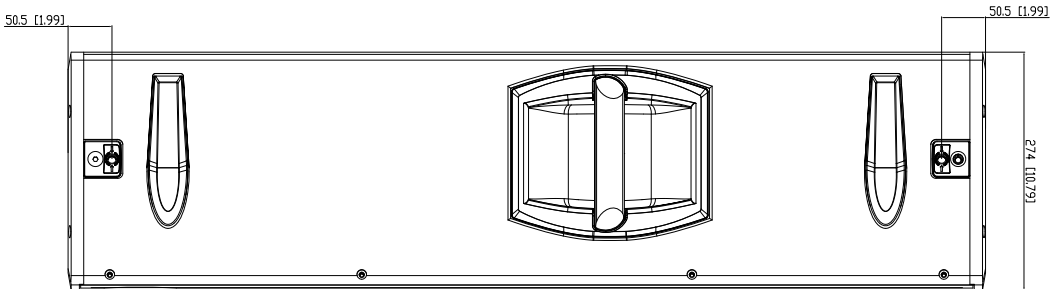
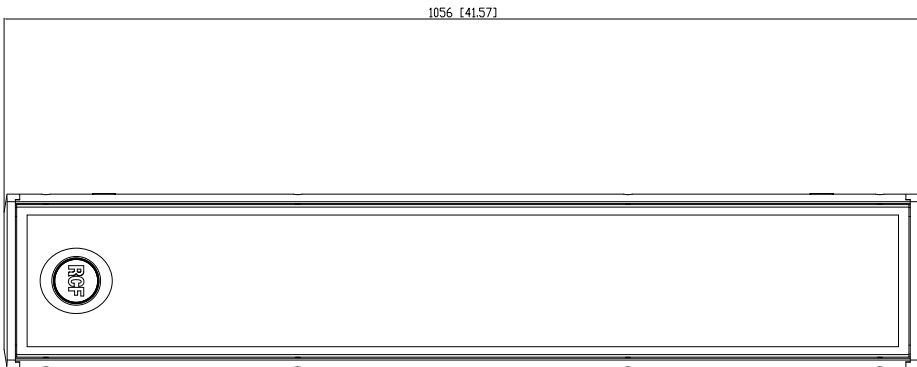
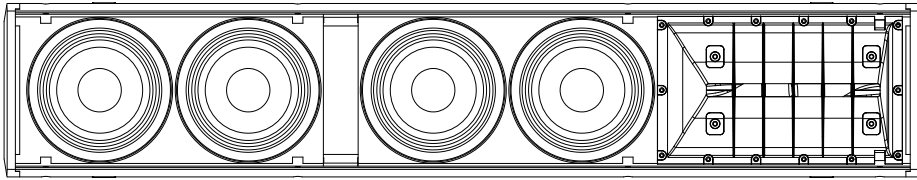

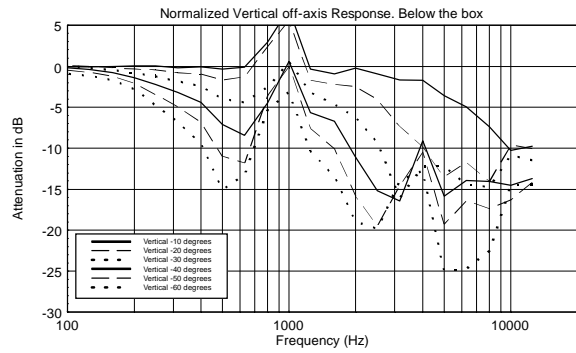
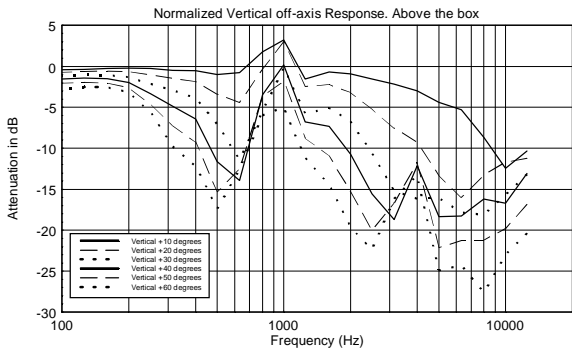
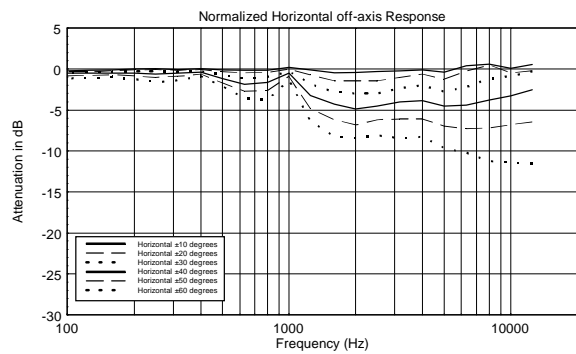
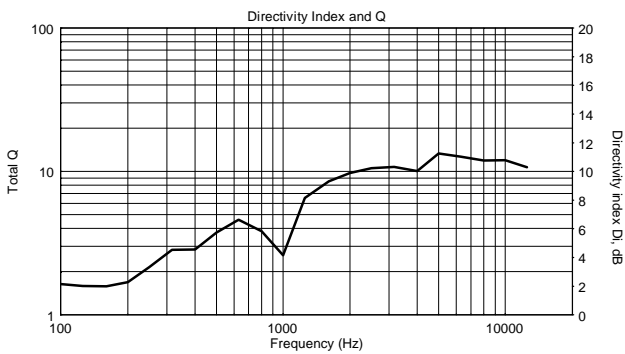
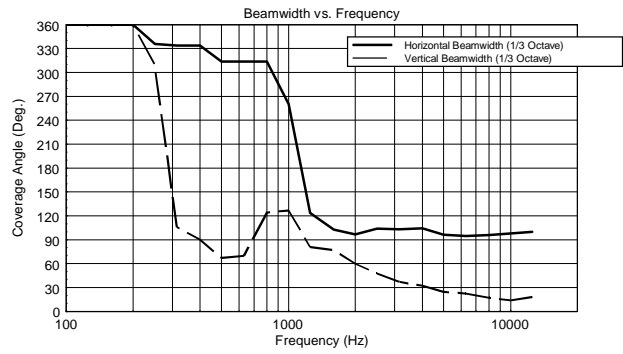
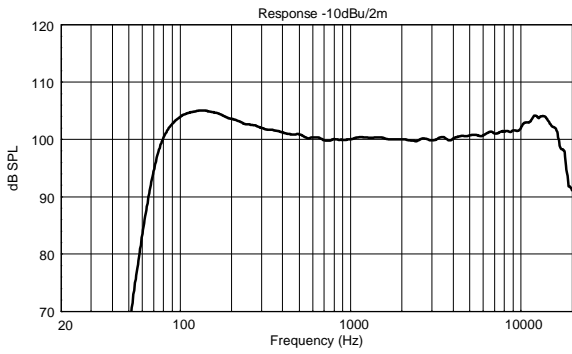

Horizontal 1/3 Octave Polars

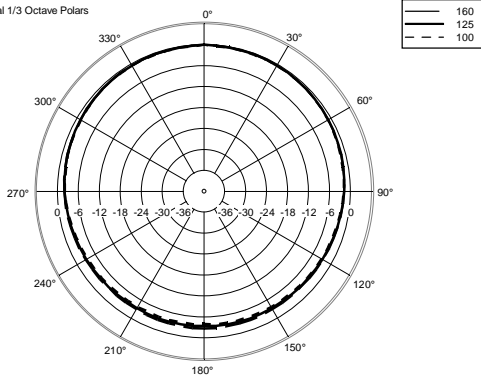

Horizontal 1/3 Octave Polars

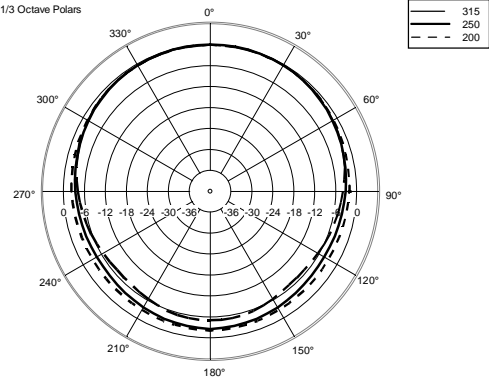

Horizontal 1/3 Octave Polars

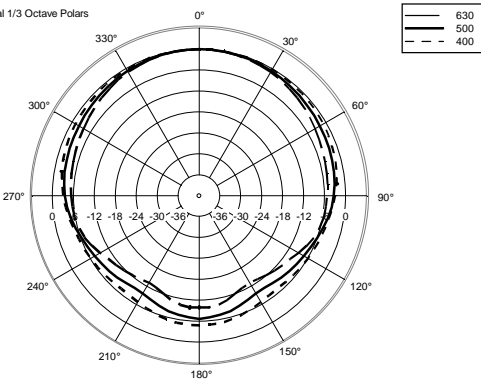

Horizontal 1/3 Octave Polars

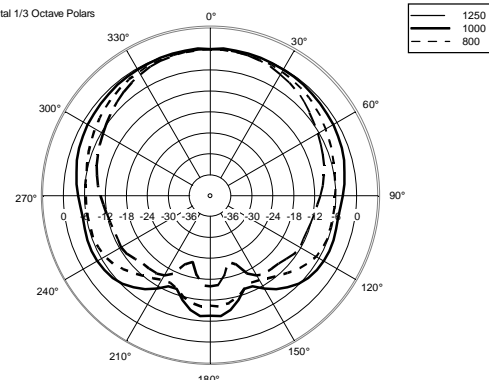

Horizontal 1/3 Octave Polars

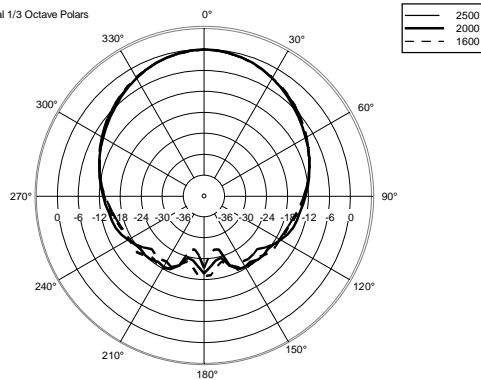

Horizontal 1/3 Octave Polars

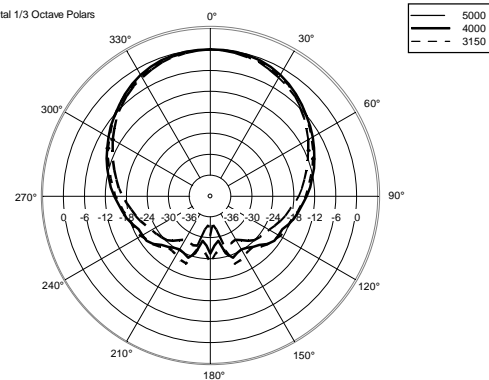

Horizontal 1/3 Octave Polars

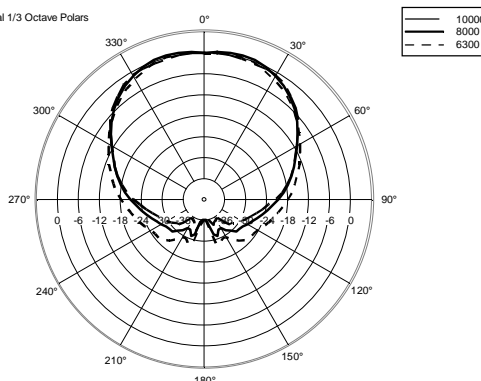



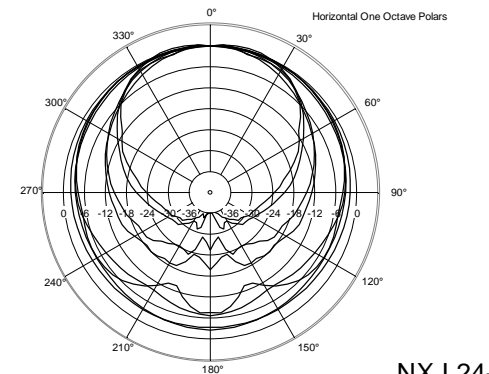

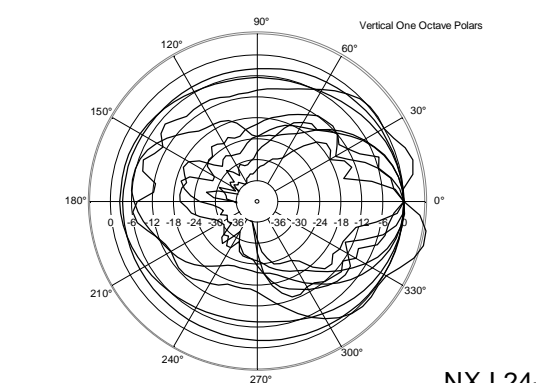
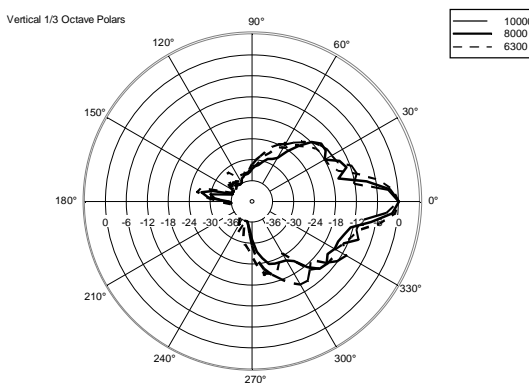
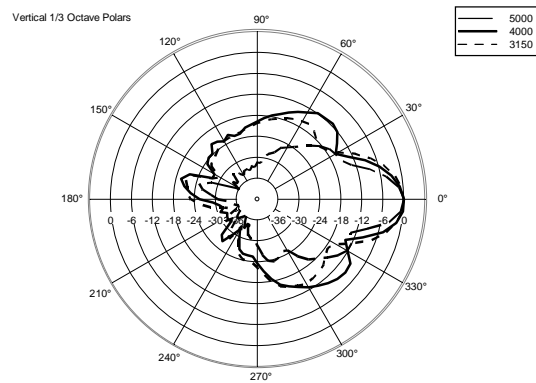
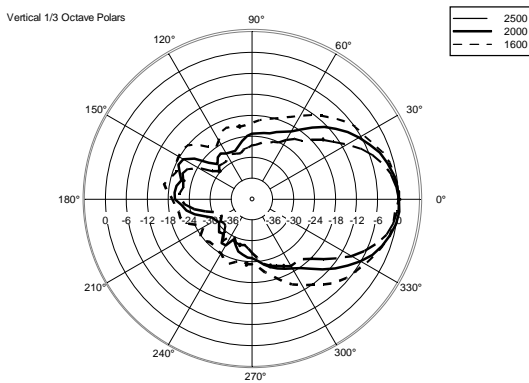
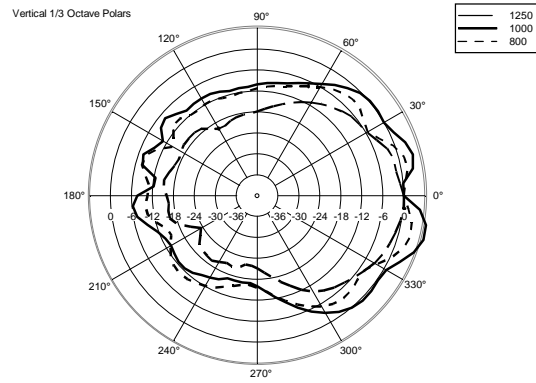
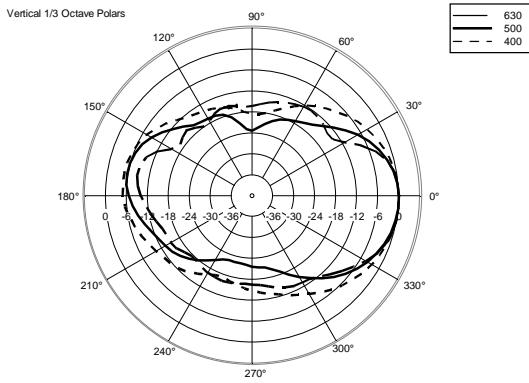
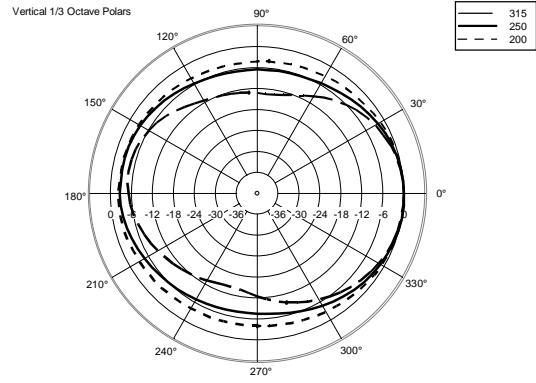
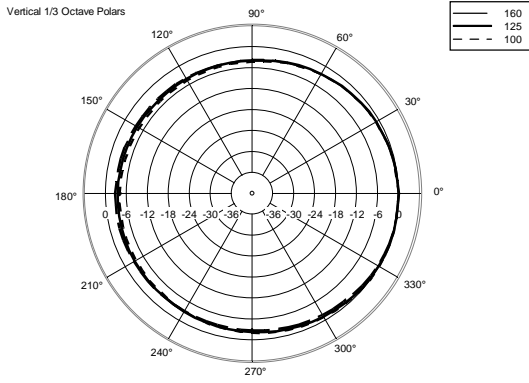



Horizontal One Octave Polars





ACCESSORIES

	AC PMA - POLE MOUNT	PART NUMBER EAN:	13360034 8024530007713
	AC PM-M20	PART NUMBER EAN:	13360067 8024530014599
	AC PMX POLE MOUNT M20	PART NUMBER EAN:	13360232 8024530010058
	AC PRO-FS PROFESS. LOCKING FLOOR STAND	PART NUMBER EAN:	13360109 8024530006471
	AC PRO-PM PROFESS. LOCKING POLE MOUNT	PART NUMBER EAN:	13360110 8024530006488
	FLY BAR FL-B NXL 24	PART NUMBER EAN:	13360278 8024530015756
	LINK BAR FL-B LINK NXL 24	PART NUMBER EAN:	13360279
	POLE MOUNT KIT NXL24-A	PART NUMBER EAN:	13360280
	STACKING KIT NXL24-A	PART NUMBER EAN:	13360281