

MQ 80P

TWO-WAY INDOOR OUTDOOR SPEAKER

DESCRIPTION

High intelligibility, high efficiency and compact design make the RCF MQ80P 2-way horn-loaded sound projector speaker system the ideal solution to get clear voice and music reproduction in mid-size environment.

Suitable for PA systems and background/foreground music systems. Thanks to its 90° X 60° constant directivity and to simple accessories it can be combined in clusters of 2 or more pieces to get wide and smooth coverage and to reduce the installation points. It is suitable for both indoor and outdoor installations (IP 55). The woofer is a high-excursion, PP coated paper cone – rubber surround design mounted in a tuned enclosure (port can be sealed for full outdoor installation).

The tweeter is a horn-loaded compression driver with phase plug, the only way to get real and crispy intelligible voice reproduction even in wide and noisy environments.

Installation of the MQ80P is quick thanks to the unique bracket with several fixing points and aiming facilities. Connections are made by a multi-pole cable. Wattage taps and voltage adjustments together with 8-ohm operation are selectable by means of a Rotary switch,



FEATURES

- 5" woofer with 1" compression driver
- Power selectable (100 V): 30 W – 10 W – 10 W – 5 W
- 94 dB sensitivity
- Colour white RAL 9016 and black RAL 7021
- Plastic body, steel grille
- Protection grade IP 55

TECHNICAL SPECIFICATIONS

Acoustical specifications	Frequency Response (-10dB):	100 Hz ÷ 20000 Hz	
	Max SPL @ 1m:	114 dB	
	Horizontal coverage angle:	90°	
	Vertical coverage angle:	60°	
	System Sensitivity:	94 dB	
Power section	Nominal Impedance (ohm):	8 ohm	
	Power Handling:	60 W RMS	
	Peak Power Handling:	240 W PEAK	
	Recommended Amplifier:	120 W	
	Crossover Frequencies:	3000 Hz	
Transducers	Compression Driver:	1 x 1.0"	
	Woofers:	5.0"	
Input/Output section	Input connectors:	Cable	
	Output connectors:	Cable	
	Constant Voltage Transformer:	100 V	
	Power selection 1:	30 W - 333 ohm	
	Power selection 2:	20 W - 500 ohm	
	Power selection 3:	10 W - 1000 ohm	
Standard compliance	IP protection grade:	IP 55	
	CE marking:	Yes	
	Physical specifications	Cabinet/Case Material:	Plastic
		Hardware:	Wall mount bracket
Grille:		Steel	
Color:		White - RAL 9016	
Size	Height:	223 mm / 8.78 inches	
	Width:	191 mm / 7.52 inches	
	Depth:	236 mm / 9.29 inches	
	Weight:	3.65 kg / 8.05 lbs	
Shipping informations	Package Height:	285 mm / 11.22 inches	
	Package Width:	305 mm / 12.01 inches	
	Package Depth:	250 mm / 9.84 inches	
	Package Weight:	4.36 kg / 9.61 lbs	



PART NUMBER

- **13000096**

MQ 80P W

White - RAL 9016

EAN 8024530005795

- **13000094**

MQ 80P B

Black - RAL 7021

EAN 8024530005771

DRAWINGS

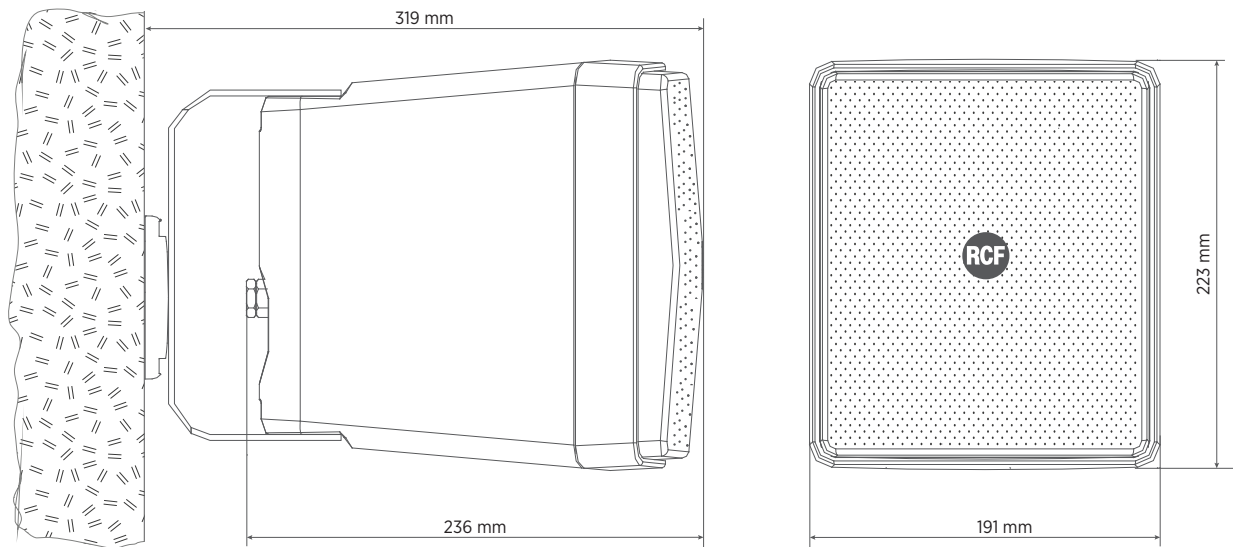

INSTALLATION

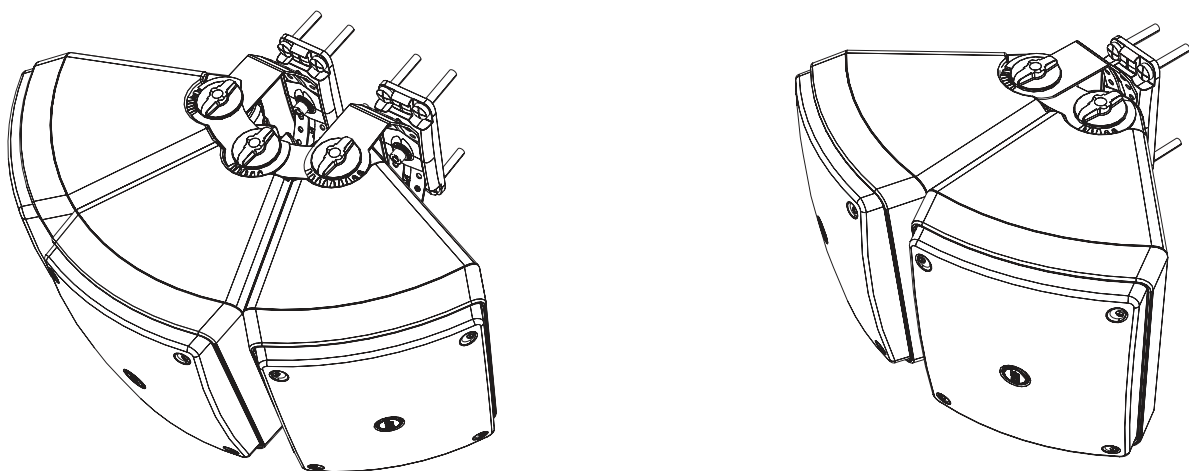

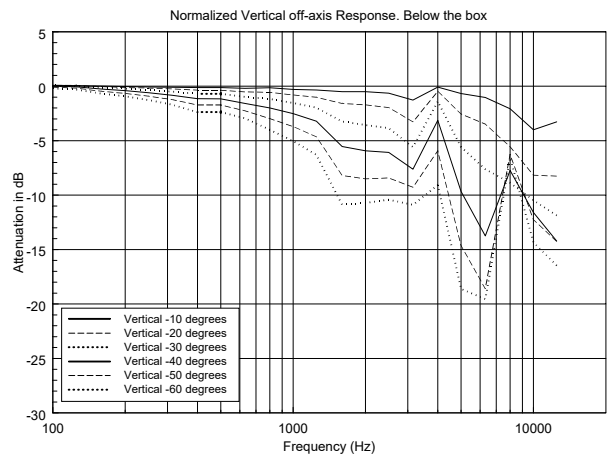
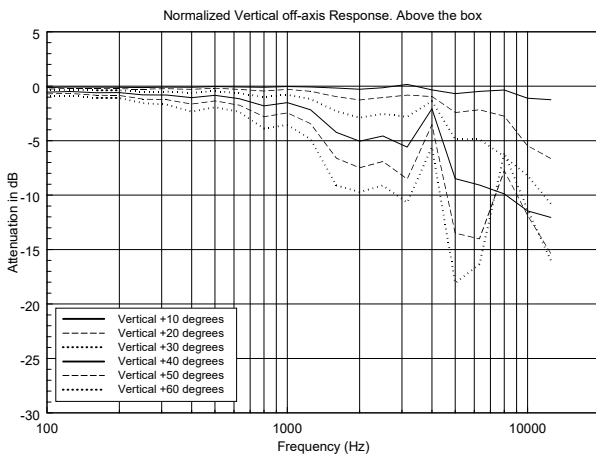
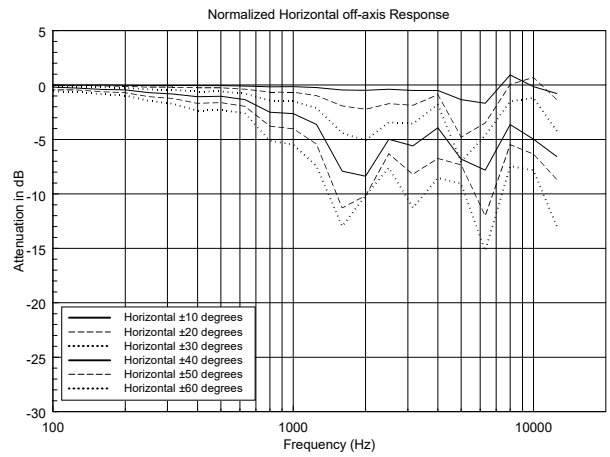
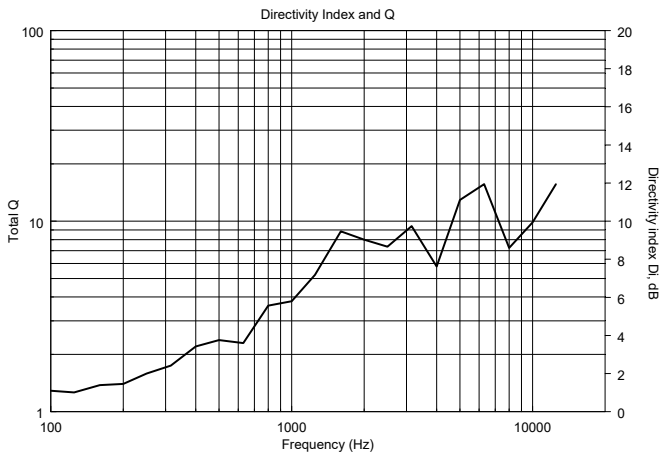
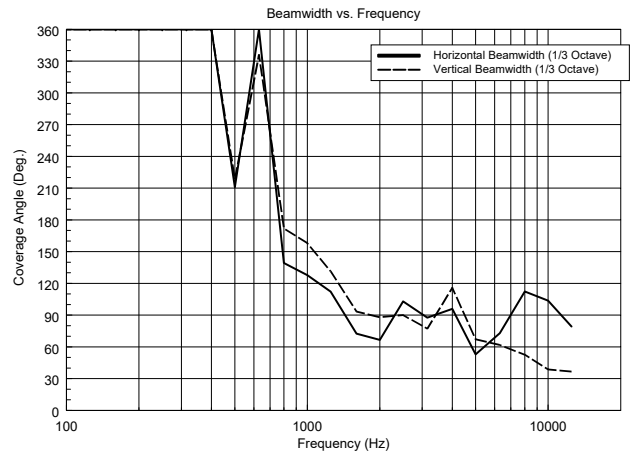
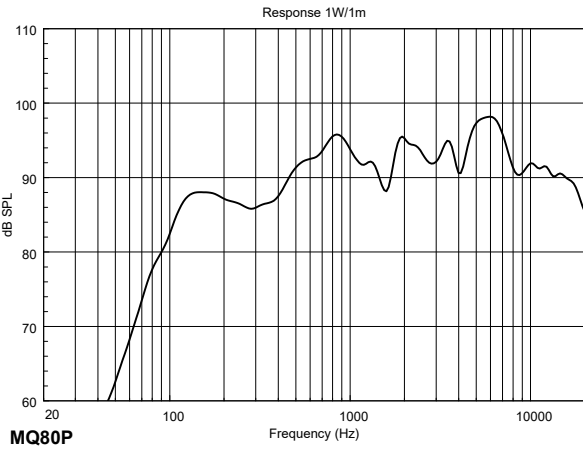

HORIZONTAL 1/3 POLAR PLOT

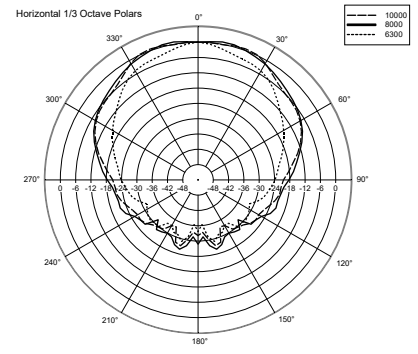
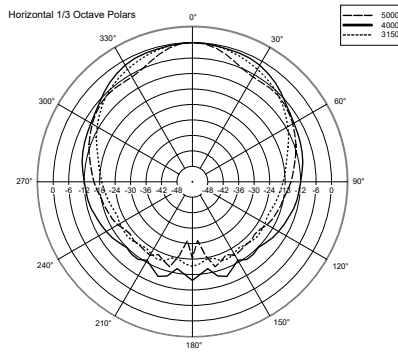
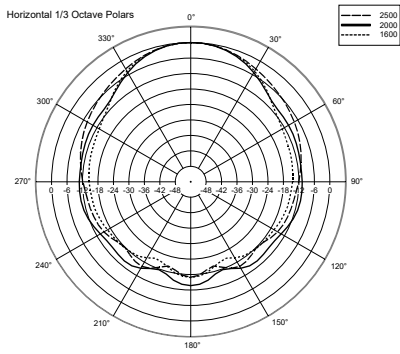
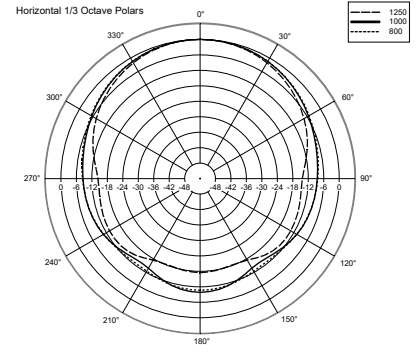
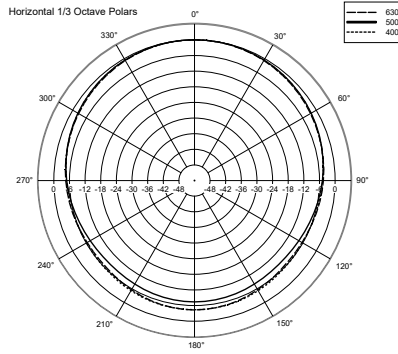
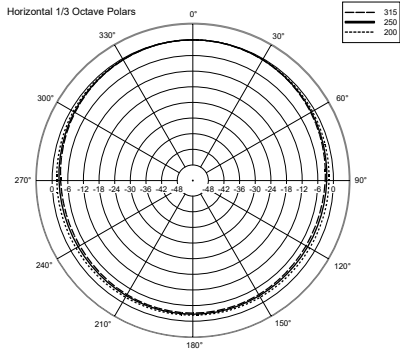

VERTICAL 1/3 POLAR PLOT

