

HL 2290

HORN LOADED TWO-WAY ARRAY 22.5° X 90°

DESCRIPTION

The HL 2290 is a horn loaded two-way full range array system that incorporates a 2 x 12" woofer and a 2.0" exit 4.0" voice coil titanium compression driver for mid distance and long throw applications. The system is very compact and provides very high output and accurate voice and sound reproduction. The system is equipped with the latest generation of RCF precision transducers. The system has a vertical dispersion of 22.5° and is ideally used in point source configuration for mid distance applications or can be clustered with narrower angles for long throw applications. The loudspeaker enclosure shape is trapezoidal and offers a 22.5° coupling angle each side. Connections to the amplifier are made through a watertight Amphenol multi-pole connector. The grille is in custom perforated steel, epoxy coated, with open-cell fibres and water repellent woven fabric backing. The cabinet is constructed of multiply Baltic birch marine plywood and finished in a very resistant, textured, polyurea black paint.



FEATURES

- 2 x 12" RCF Precision woofers with 3.5" voice coil
- RCF Precision 4.0" voice coil compression driver, titanium dome
- Horn loading on RCF waveguide
- 141 dB Max SPL
- System Power rating 1500 Watt RMS (1350 Watt LF, 150 Watt HF)
- Safe and solid variable array mechanics
- Baltic Birch Plywood enclosure with internal structural metal bracings

TECHNICAL SPECIFICATIONS

Acoustical specifications	Frequency Response (-10dB):	60 Hz ÷ 20000 Hz
	Frequency Response (-3dB):	80 Hz ÷ 20000 Hz
	Max SPL @ 1m:	141 dB
	Horizontal coverage angle:	90°
	Vertical coverage angle:	23°
	Directivity index Q:	16
	System Sensitivity:	113 dB
Power section	Nominal Impedance (ohm):	8 ohm
	Power Handling:	1500 W RMS
	Peak Power Handling:	6000 W PEAK
	Recommended Amplifier:	3000 W
	Crossover Frequencies:	600 Hz
Transducers	Compression Driver:	1 x 1.4" neo, 4.0" v.c
	Nominal Impedance (ohm):	8 ohm
	Input Power Rating:	150 W AES, 300 W PROGRAM POWER
	Sensitivity:	113 dB, 1W @ 1m
	Woofer:	2 x 12", 3.5" v.c
	Nominal Impedance (ohm):	8 ohm
	Input Power Rating:	1350 W AES, 2700 W PROGRAM POWER
Sensitivity:	104 dB, 1W @ 1m	
Input/Output section	Input connectors:	Amphenol eco/mat IP 67
	Output connectors:	Amphenol eco/mat IP 67
Standard compliance	CE marking:	Yes
Physical specifications	Cabinet/Case Material:	Baltic birch plywood
	Hardware:	Side and rear array rigging point
	Grille:	Steel
	Color:	Black
Size	Height:	530 mm / 20.87 inches
	Width:	771 mm / 30.35 inches
	Depth:	635 mm / 25 inches
	Weight:	69 kg / 152.12 lbs
Shipping informations	Package Height:	799 mm / 31.46 inches
	Package Width:	859 mm / 33.82 inches
	Package Depth:	619 mm / 24.37 inches
	Package Weight:	70.5 kg / 155.43 lbs



PART NUMBER

- **13000405**

HL 2290

EAN 8024530011604

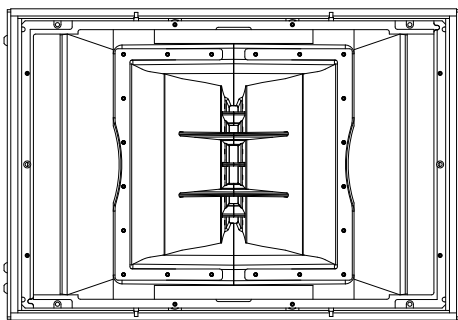
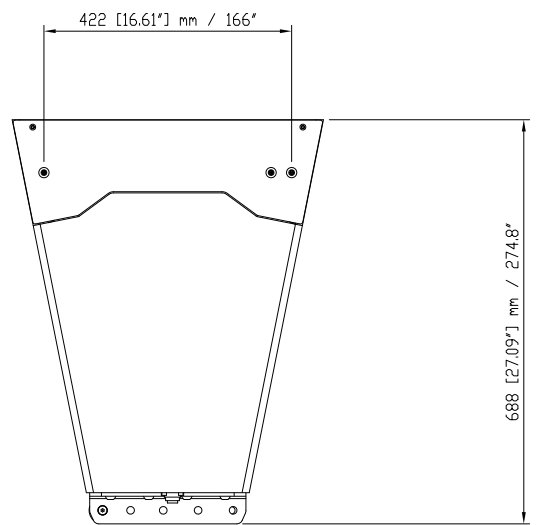
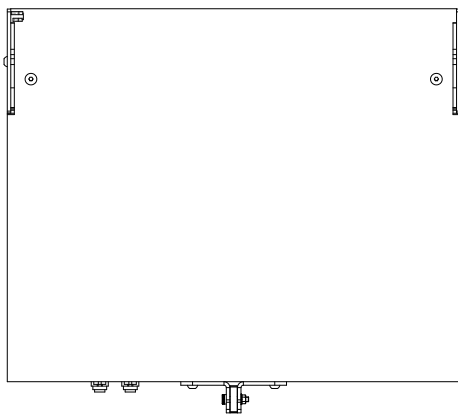
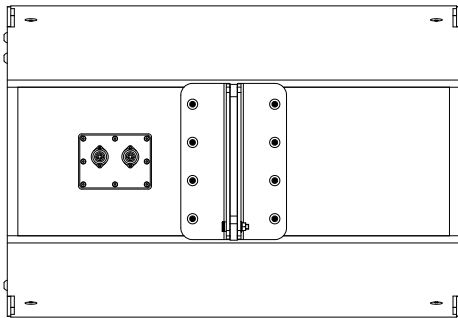

HL 2290
69 KG

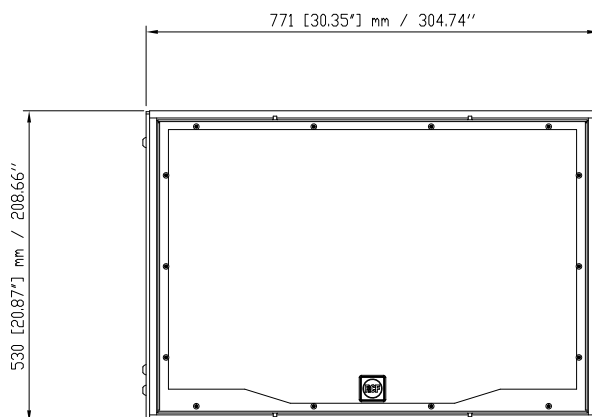

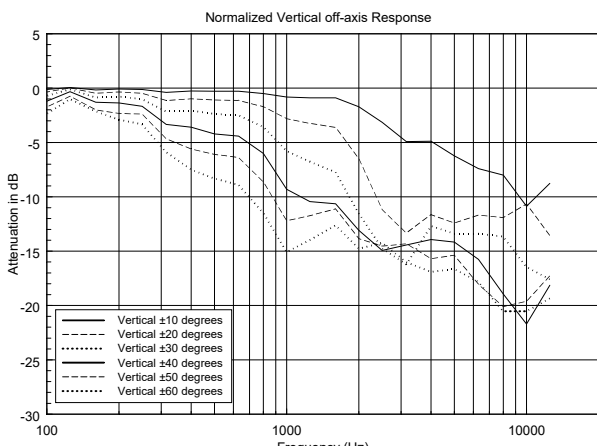
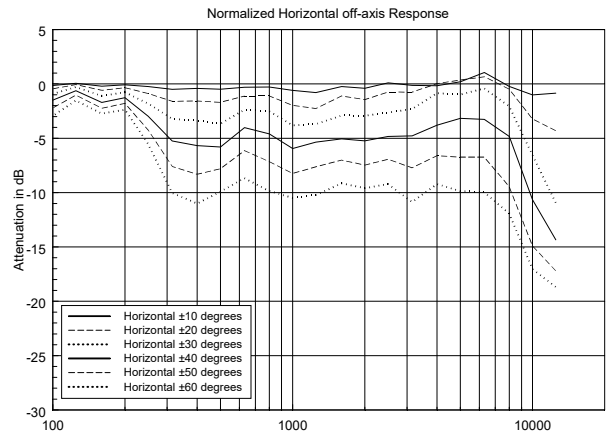
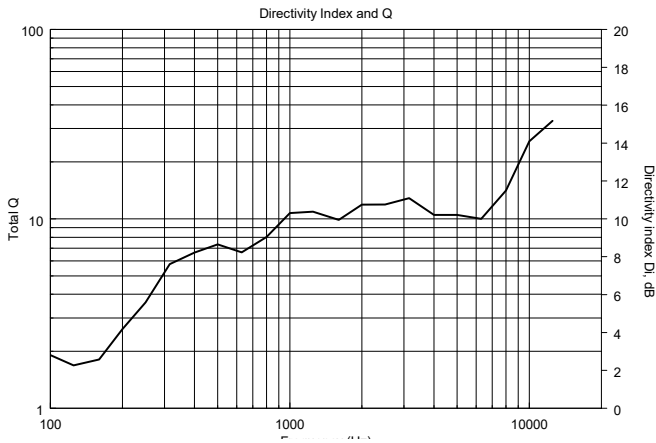
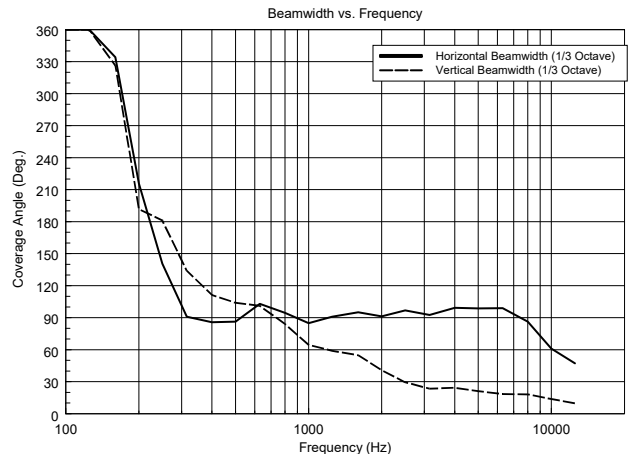
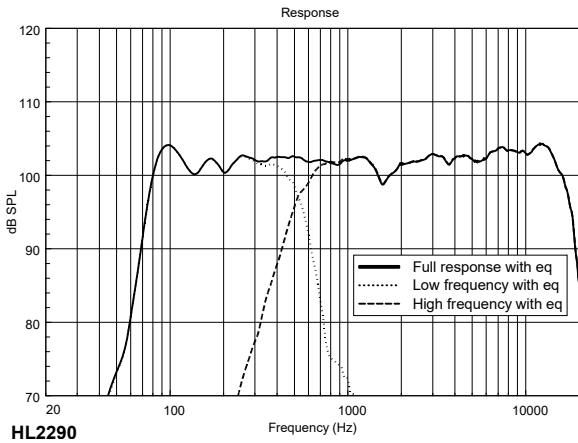

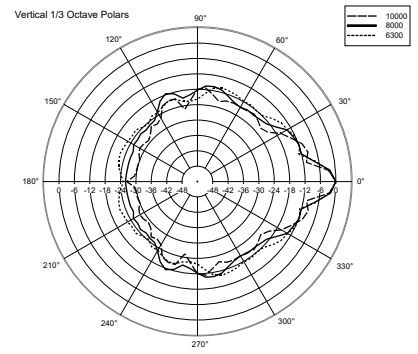
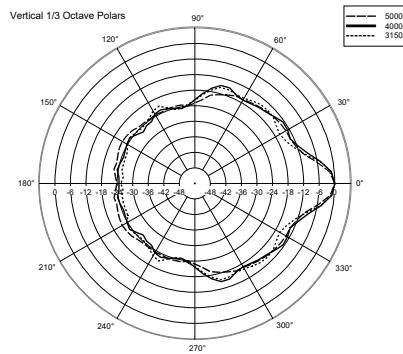
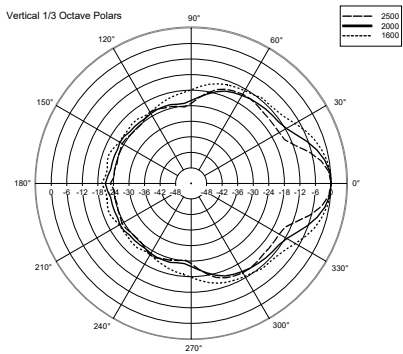
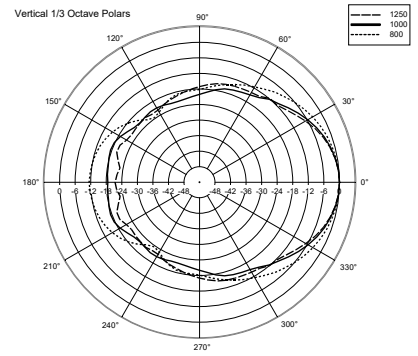
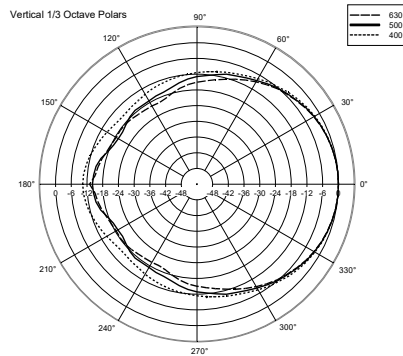
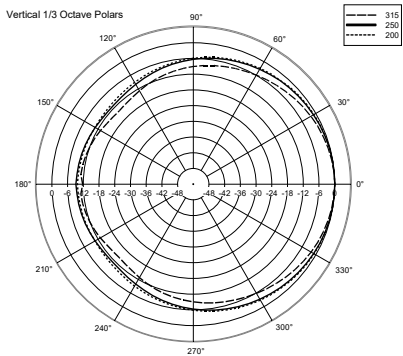
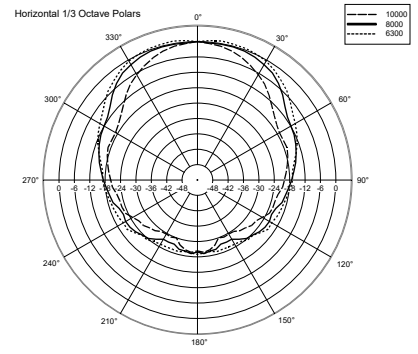
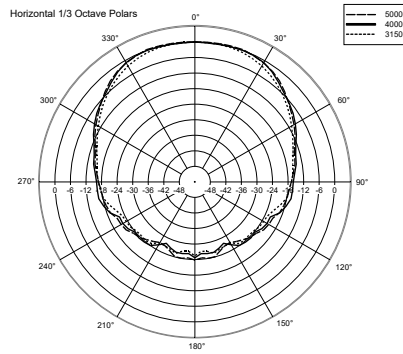
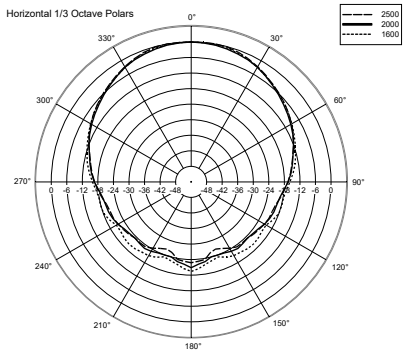
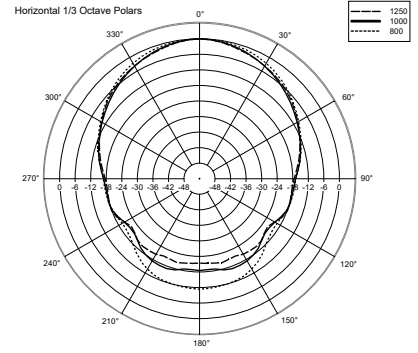
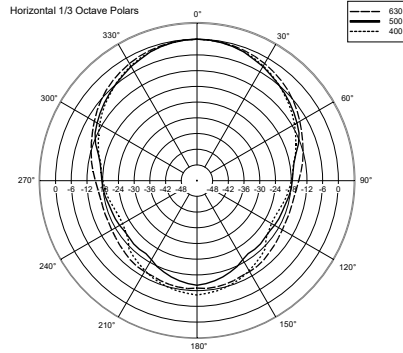
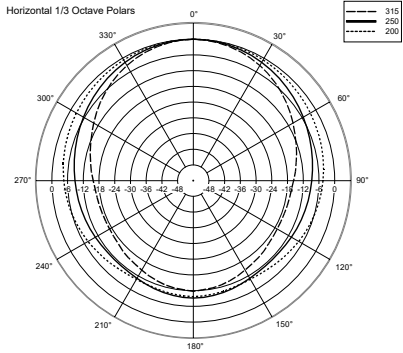

ACCESSORIES



FLY BAR FL-B HL

PART NUMBER **13360282**
EAN: 8024530011734
