

# HD 35-A

## ACTIVE TWO-WAY SPEAKER

### DESCRIPTION

The titanium dome, voice coil neodymium compression driver offers unique vocal clarity and sound projection on the HD 35-A. The 15" woofer offers an extremely linear response and a precise, deep low-frequency control. The amplifier delivers 1400 watts and is controlled by a DSP that takes care of crossover, equalization, FiRPHASE, soft limiting, and speaker protection.



### FEATURES

- 132 dB Max SPL
- 1400 Watts 2-way peak power
- DSP Processing with FiRPHASE
- 1.4" Titanium Compression Driver, 3.0" v.c. Neodymium
- 15" Woofer, high power
- 800 Hz crossover point for perfect vocal reproduction
- 90°x60°, wide dispersion constant directivity horn
- Silent Fanless Class-D Amplifier

## TECHNICAL SPECIFICATIONS

<b>Acoustical specifications</b>	Frequency Response:	45 Hz ÷ 20000 Hz
	Max SPL @ 1m:	132 dB
	Horizontal coverage angle:	90°
	Vertical coverage angle:	60°
<b>Transducers</b>	Compression Driver:	1.4", 3.0" v.c
	Woofers:	15", 3.0" v.c
<b>Input/Output section</b>	Input signal:	bal/unbal
	Input connectors:	XLR, Jack
	Output connectors:	XLR
	Input sensitivity:	-2 dBu/+4 dBu
	Mic. Input Sensitivity:	-32 dBu
<b>Processor section</b>	Crossover Frequencies:	800 Hz
	Protections:	Thermal, RMS
	Limiter:	Soft Limiter
	Controls:	Volume, Boost, Mic/Line
<b>Power section</b>	Total Power:	1400 W Peak, 700 W RMS
	High frequencies:	400 W Peak, 200 W RMS
	Low frequencies:	1000 W Peak, 500 W RMS
	Cooling:	Convection
	Connections:	Powercon IN/OUT
<b>Standard compliance</b>	CE marking:	Yes
<b>Physical specifications</b>	Cabinet/Case Material:	PP Composite
	Hardware:	1 x M10 top, 1 x M10 bottom, 2 x M10 side
	Handles:	1 Top, 2 Side
	Pole mount/Cap:	Yes
	Grille:	Steel
	Color:	Black
<b>Size</b>	Height:	714 mm / 28.11 inches
	Width:	442 mm / 17.4 inches
	Depth:	397 mm / 15.63 inches
	Weight:	22 kg / 48.5 lbs
<b>Shipping informations</b>	Package Height:	750 mm / 29.53 inches
	Package Width:	440 mm / 17.32 inches
	Package Depth:	480 mm / 18.9 inches
	Package Weight:	24.5 kg / 54.01 lbs



**PART NUMBER**

• **13000592**

HD 35-A

115V

EAN 8024530016920

• **13000591**

HD 35-A

230V

EAN 8024530016661

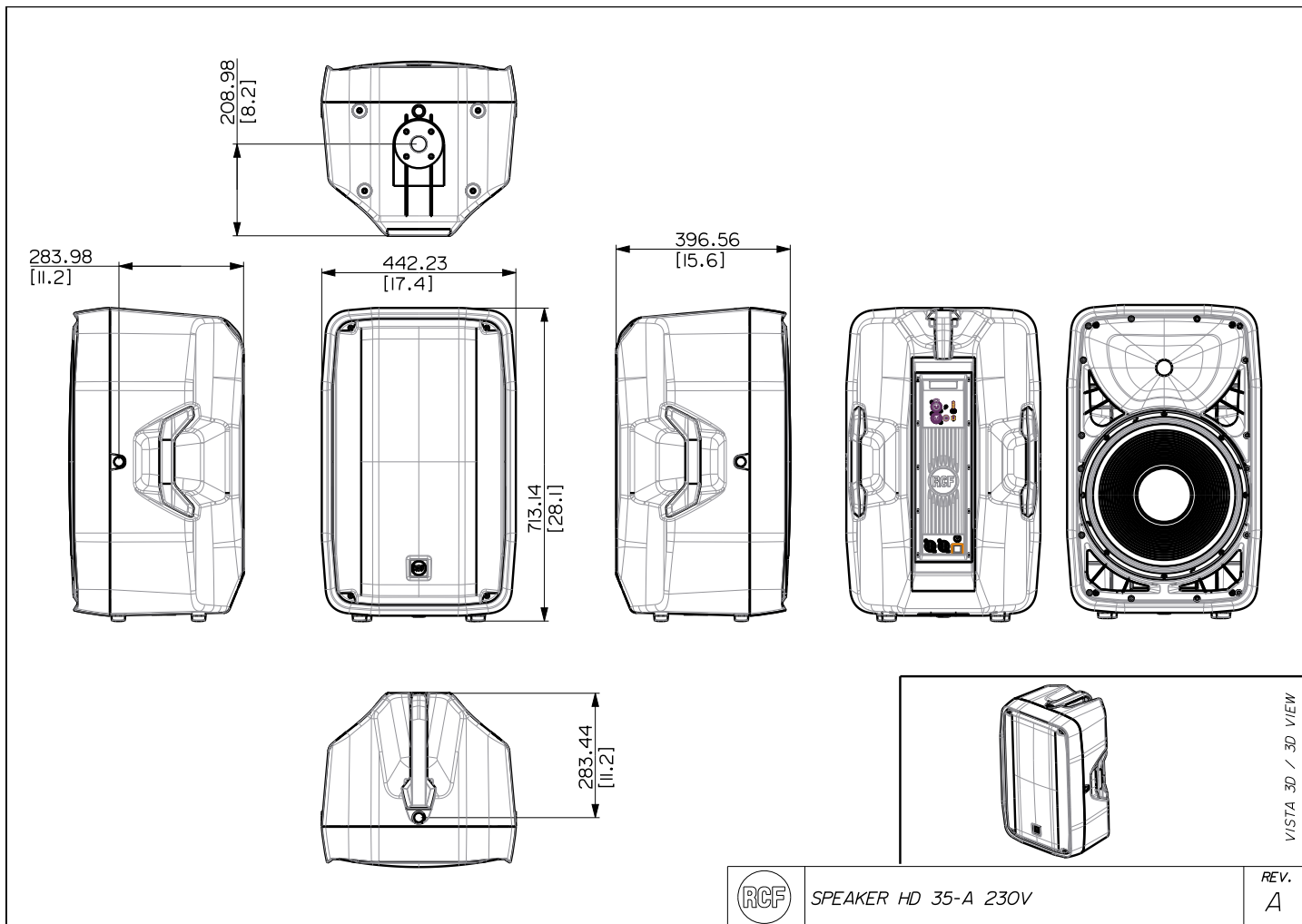

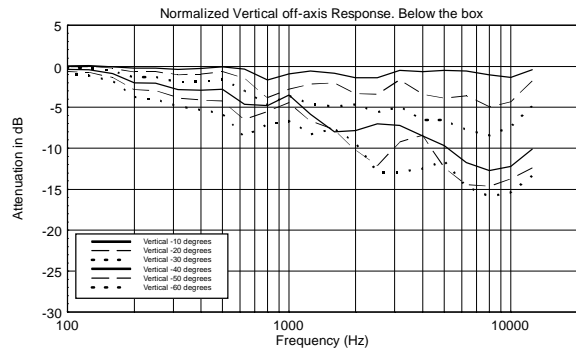
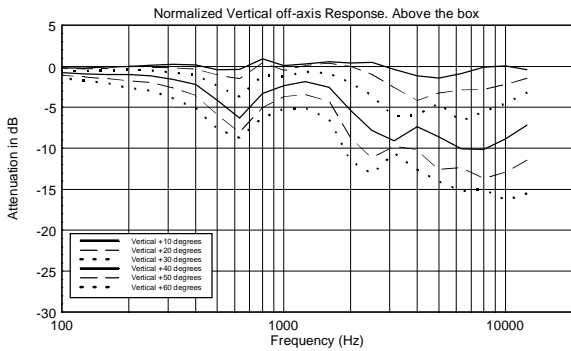
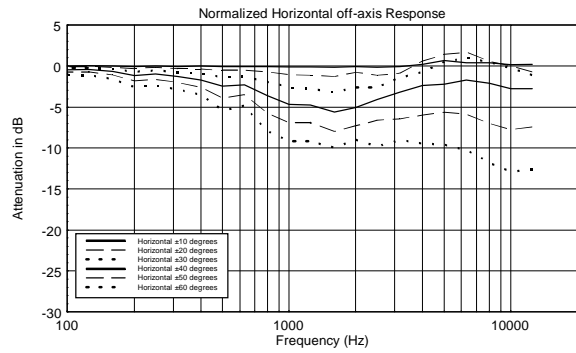
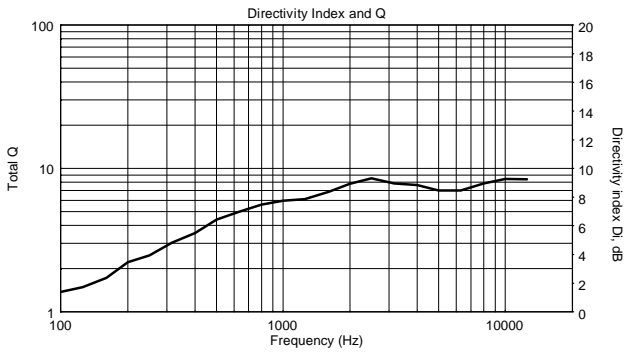
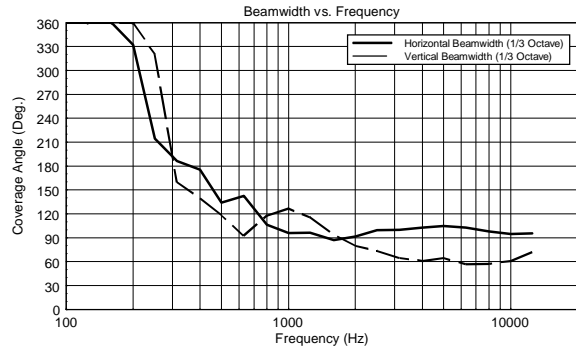
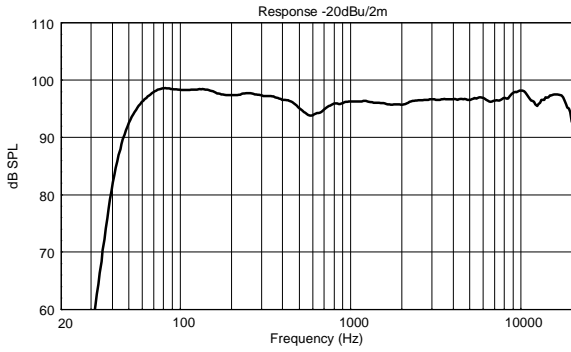

Horizontal 1/3 Octave Polars

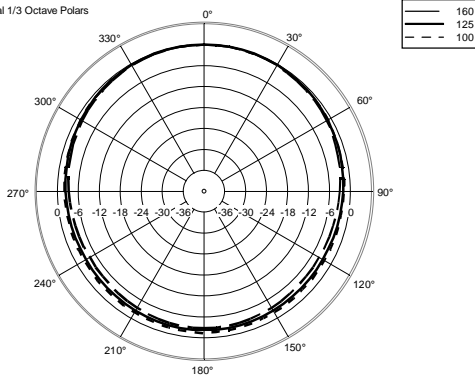

Horizontal 1/3 Octave Polars

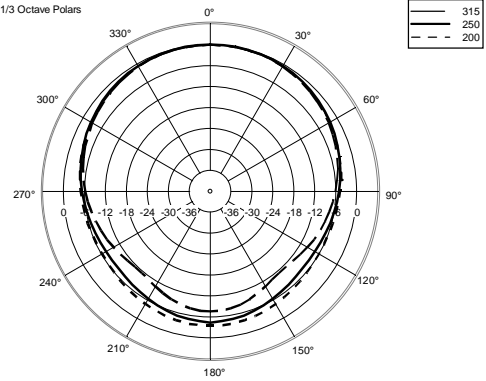

Horizontal 1/3 Octave Polars

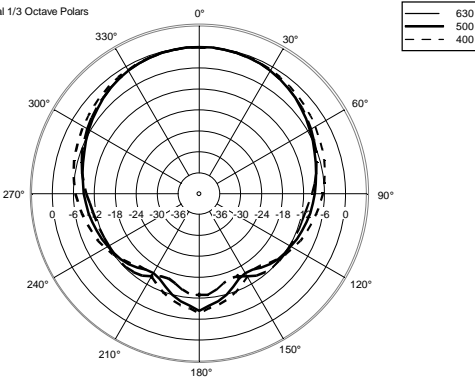

Horizontal 1/3 Octave Polars

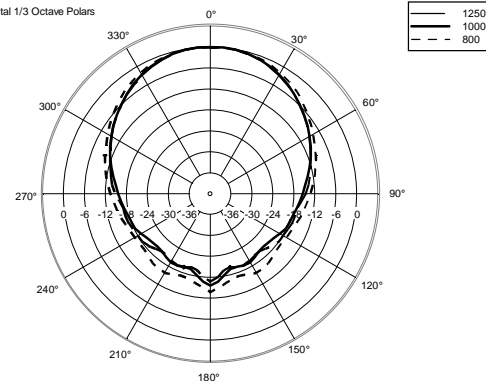

Horizontal 1/3 Octave Polars

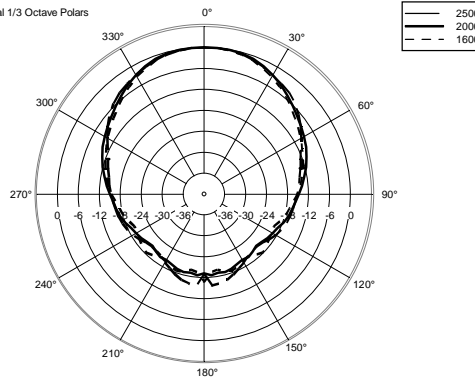

Horizontal 1/3 Octave Polars

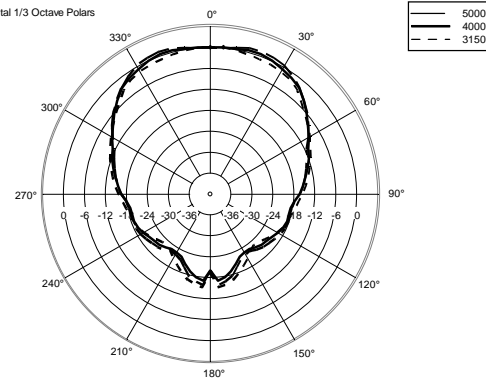

Horizontal 1/3 Octave Polars

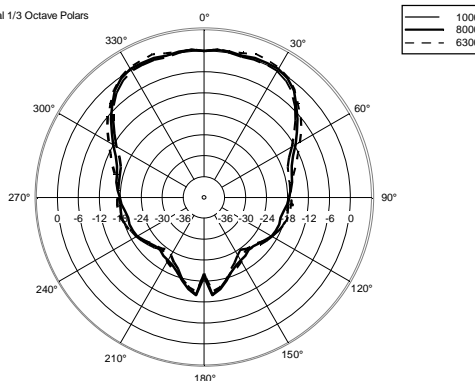

Horizontal One Octave Polars

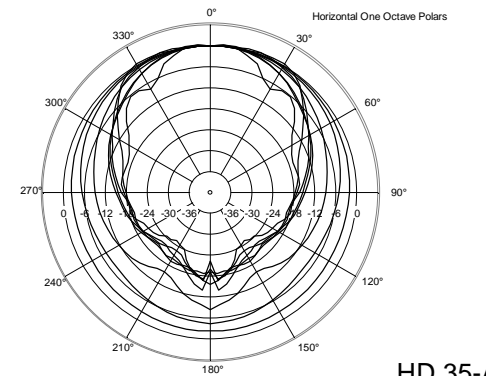

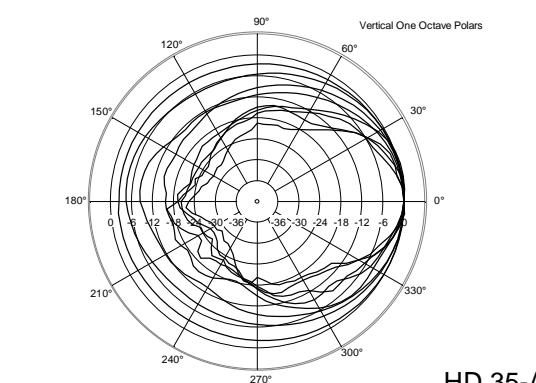
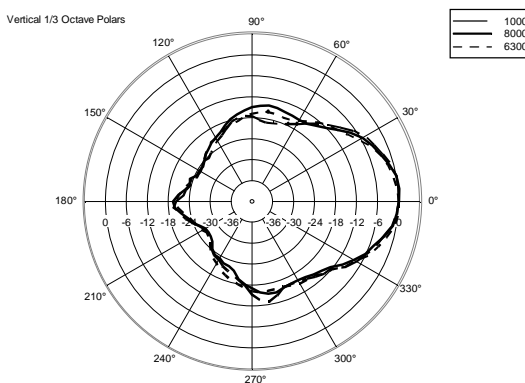
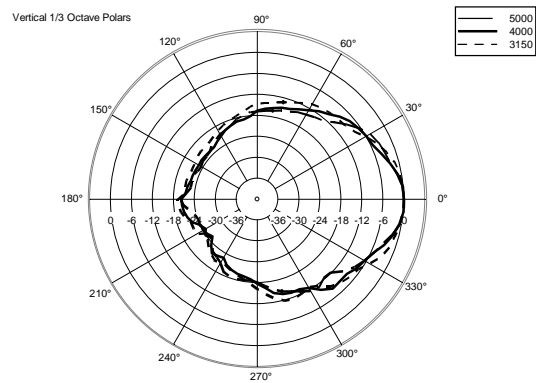
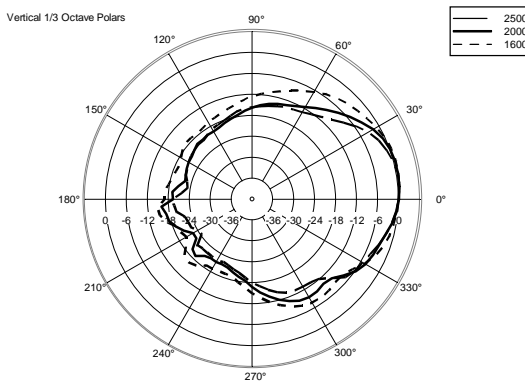
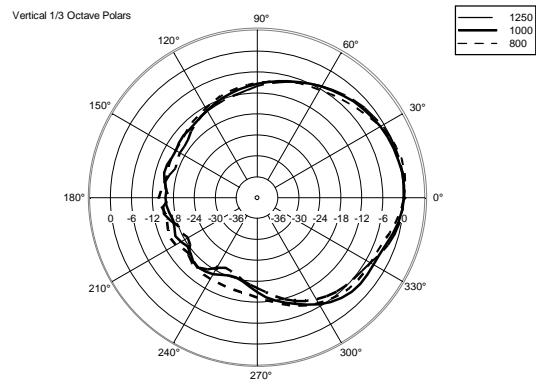
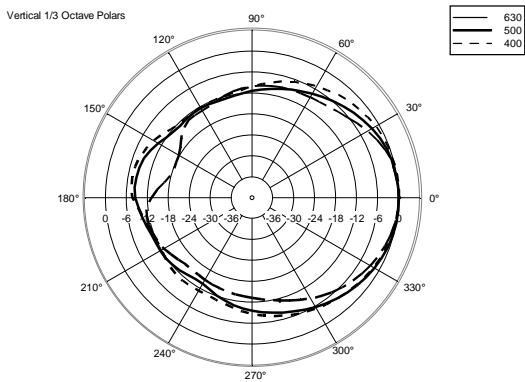
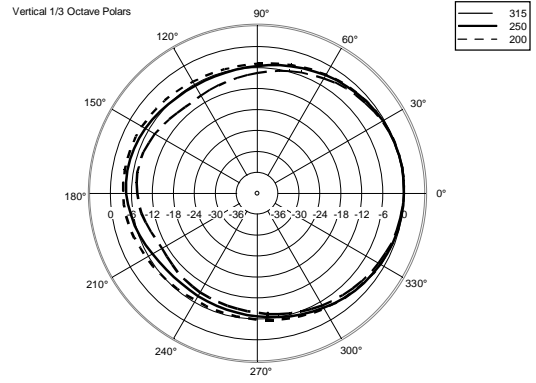
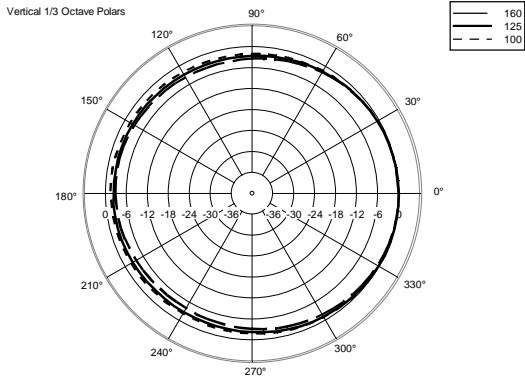

**ACCESSORIES**

AC PMA - POLE MOUNT

PART NUMBER **13360034**  
EAN: 8024530007713

AC PM-M20

PART NUMBER **13360067**  
EAN: 8024530014599

AC PMX POLE MOUNT M20

PART NUMBER **13360232**  
EAN: 8024530010058

AC PRO-FS PROFESS. LOCKING FLOOR STAND

PART NUMBER **13360109**  
EAN: 8024530006471

AC PRO-PM PROFESS. LOCKING POLE MOUNT

PART NUMBER **13360110**  
EAN: 8024530006488

COVER CVR HD 15

PART NUMBER **13360438**  
EAN: 8024530016708

KIT EYEBOLT 4 X

PART NUMBER **13360031**  
EAN: