

C 5215-99

TWO-WAY PASSIVE SPEAKER

DESCRIPTION

The C5215-99 is a full range extremely versatile controlled narrow dispersion two-way loudspeaker system for medium throw applications.

The high-frequency section is a constant directivity horn loaded to a 2" compression driver with a 2.5" diaphragm assembly for smooth, controlled dispersion. The 90° x 90° horn design offers higher sensitivity for longer distance applications. The low-frequency transducer is a 15" woofer with a 3" voice coil. The crossover is easily bypassed for bi-amp via a recessed changeover switch.



FEATURES

- 90° x 90° CMD (Coverage Matching Design) constant directivity horn
- 1.4" compression driver with 2,5" diaphragm assembly
- 15" woofer with 3" voice coil
- Dual-function design: built in passive crossover or external bi-amp
- Rotatable Horn System for horizontal cabinet mounting applications
- HF driver AMCDP (Active Mosfet Compression Driver Protection)
- LICC (Low Impedance Compensated Crossover) network
- 14 Suspension points (M10)
- 35 mm standard internal pole mount

TECHNICAL SPECIFICATIONS

Acoustical specifications	Frequency Response (-10dB):	48 Hz ÷ 20000 Hz
	Max SPL @ 1m:	133 dB
	Horizontal coverage angle:	90°
	Vertical coverage angle:	90°
	Directivity index Q:	11
	System Sensitivity:	100 dB
Power section	Nominal Impedance (ohm):	8 ohm
	Power Handling:	500 W RMS
	Peak Power Handling:	2000 W PEAK
	Recommended Amplifier:	1000 W
	Protections:	Dynamic active mosfet
	Crossover Frequencies:	1200 Hz
Transducers	Compression Driver:	1.4", 2.5" v.c
	Nominal Impedance (ohm):	8 ohm
	Input Power Rating:	100 W AES, 200 W PEAK
	Sensitivity:	111 dB, 1W @ 1m
	Woofer:	15", 3.0" v.c
	Nominal Impedance (ohm):	8 ohm
	Input Power Rating:	400 W AES, 800 W PEAK
Sensitivity:	99 dB, 1W @ 1m	
Input/Output section	Input connectors:	Speakon® NL4
	Output connectors:	Speakon® NL4
Standard compliance	CE marking:	Yes
Physical specifications	Cabinet/Case Material:	Baltic birch plywood
	Hardware:	14 x M10, multiplates (top and bottom)
	Pole mount/Cap:	Yes
	Grille:	Steel with robust double mesh polyester clothing
	Color:	Black
Size	Height:	695 mm / 27.36 inches
	Width:	430 mm / 16.93 inches
	Depth:	460 mm / 18.11 inches
	Weight:	35 kg / 77.16 lbs
Shipping informations	Package Height:	779 mm / 30.67 inches
	Package Width:	584 mm / 22.99 inches
	Package Depth:	534 mm / 21.02 inches
	Package Weight:	38.5 kg / 84.88 lbs



PART NUMBER

- **13000313**

C 5215-99

EAN 8024530009311

S5215 NEW

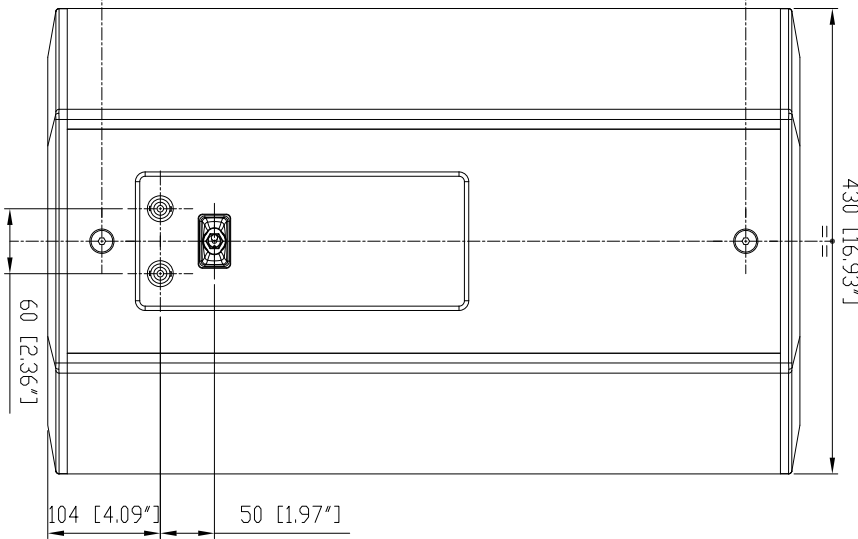
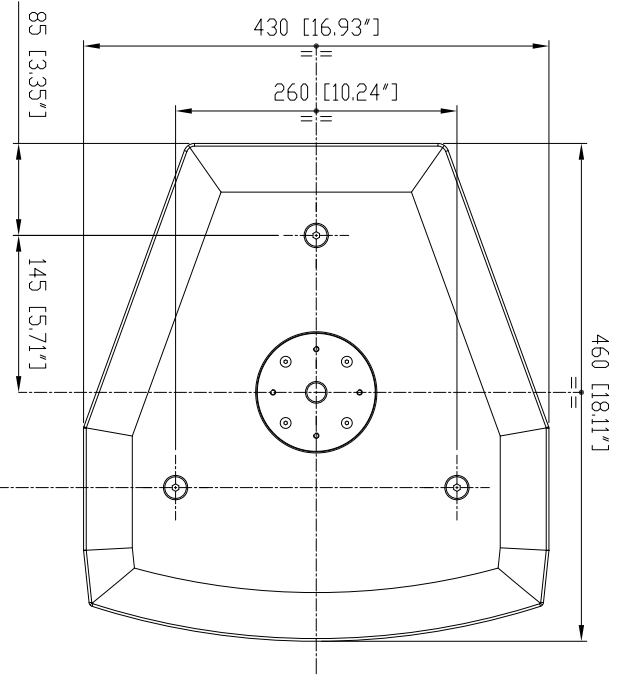
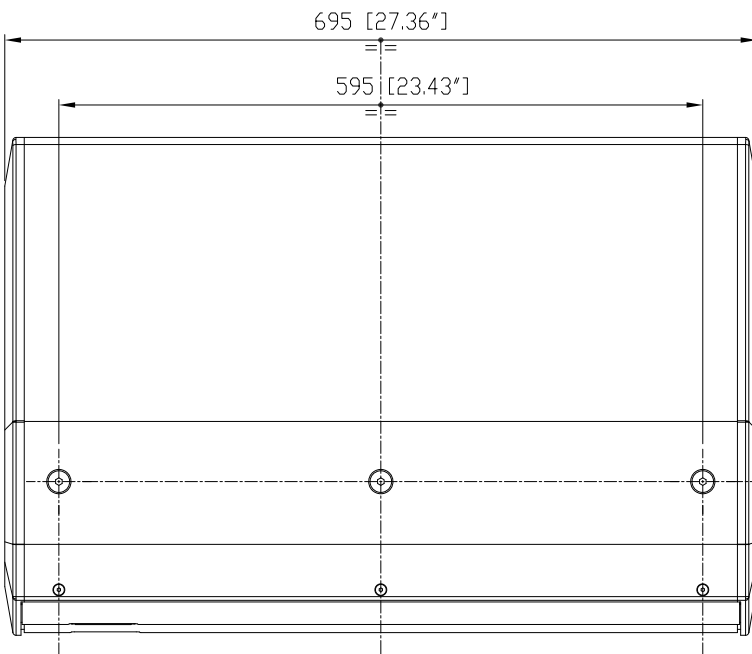
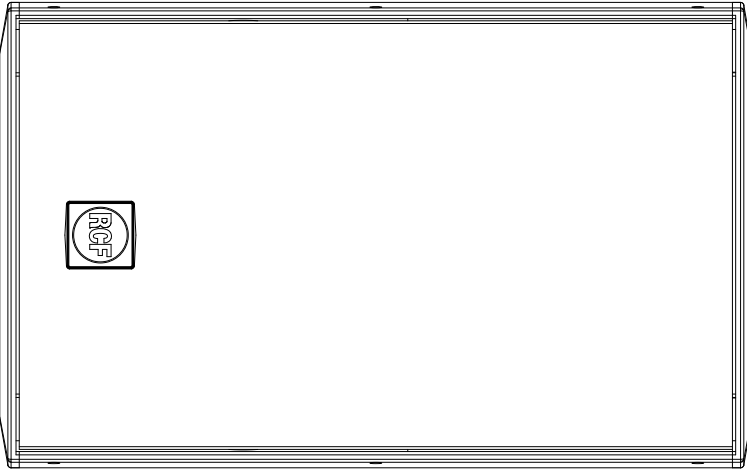

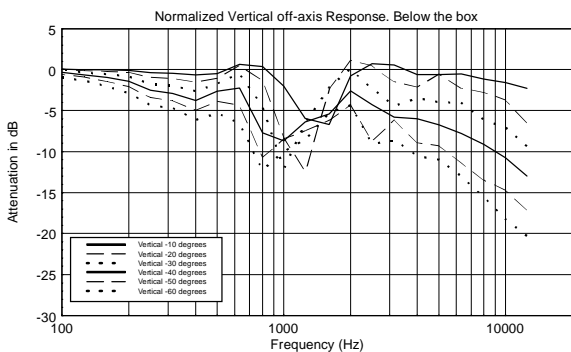
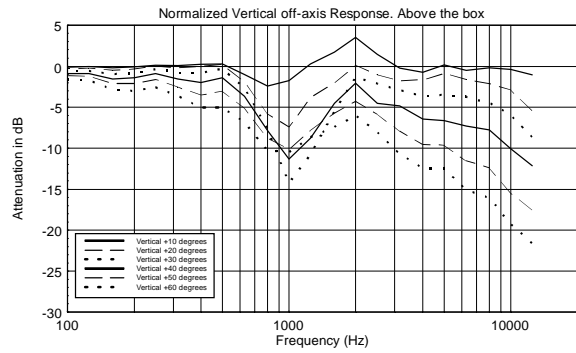
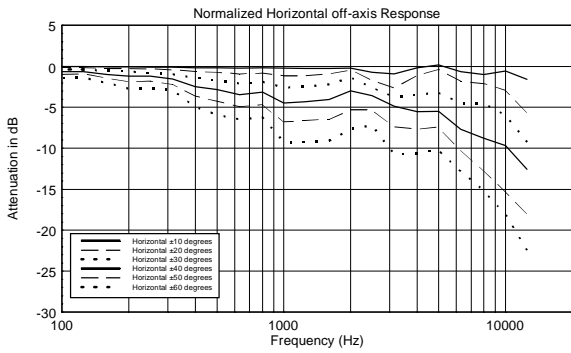
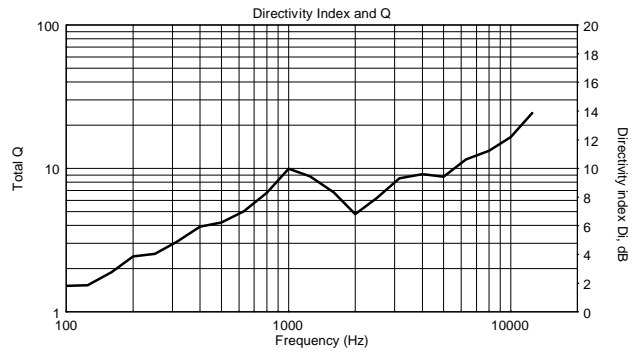
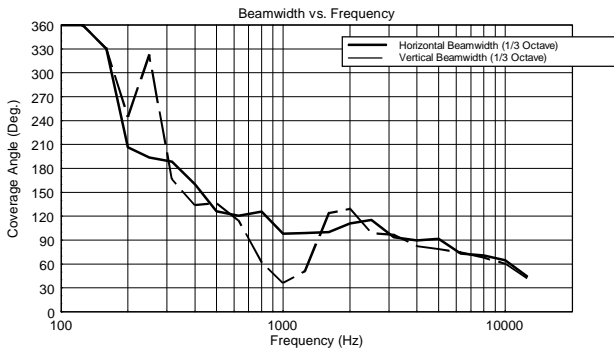
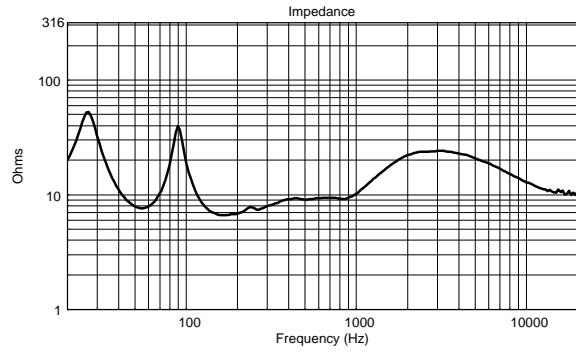
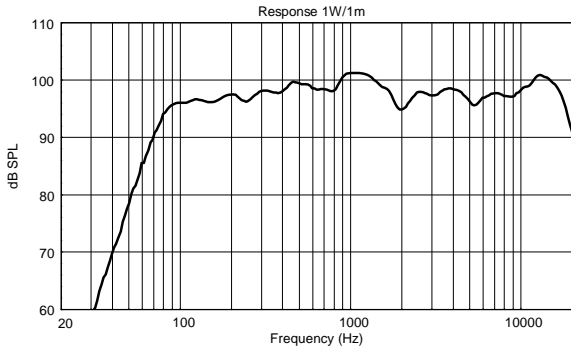

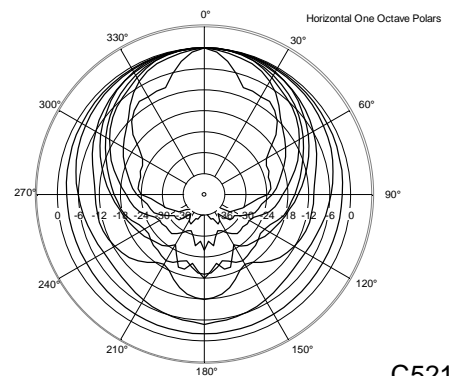
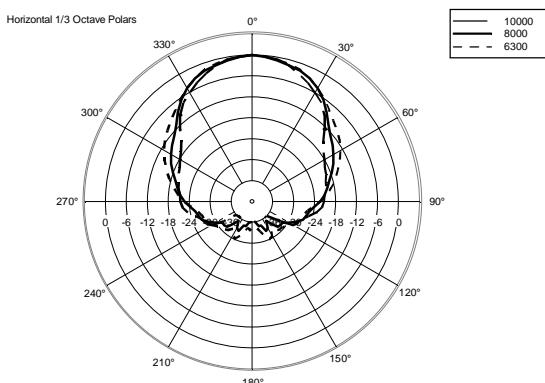
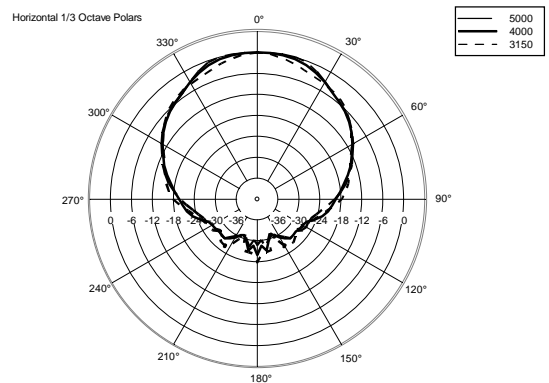
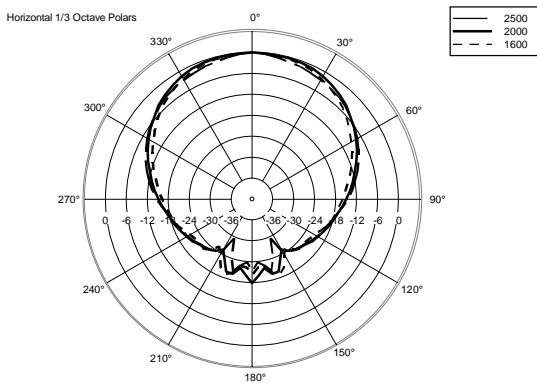
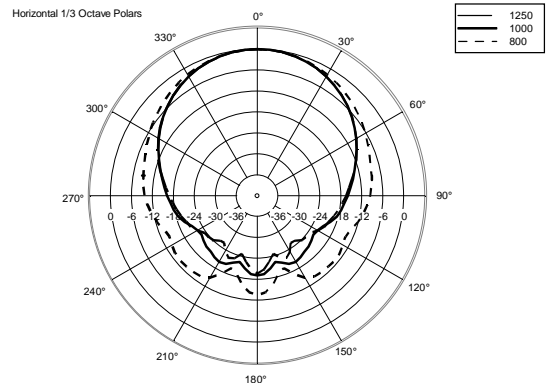
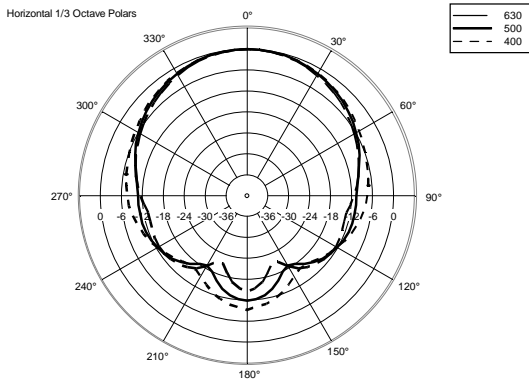
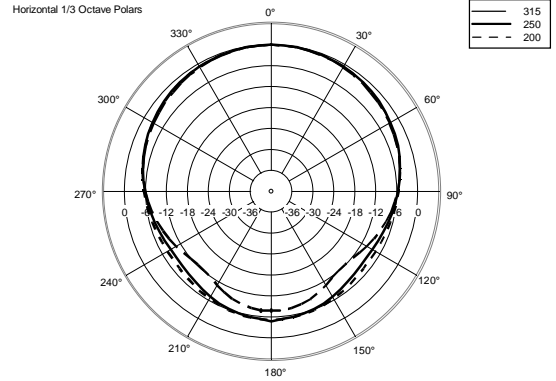
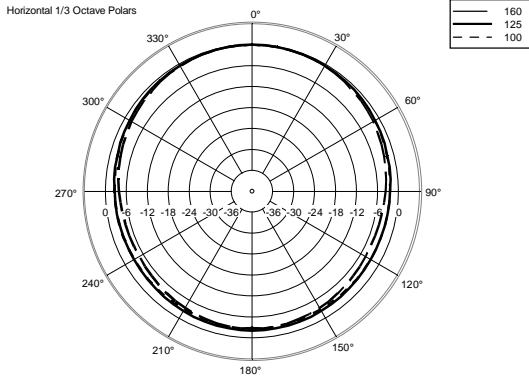

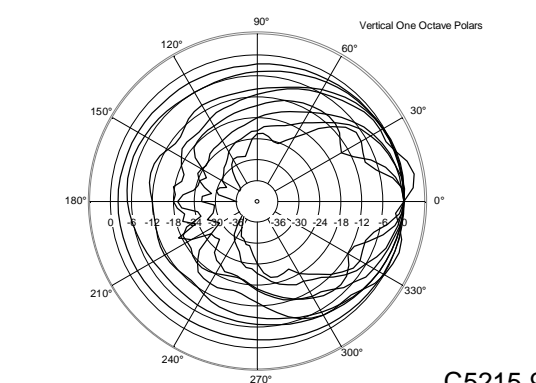
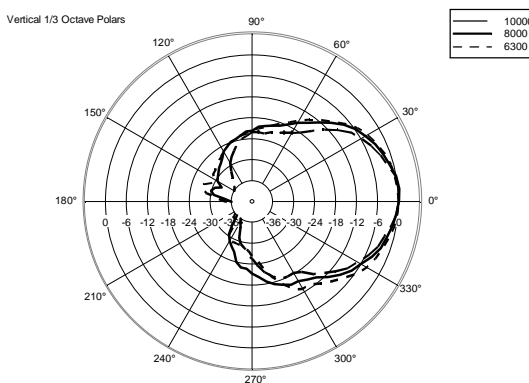
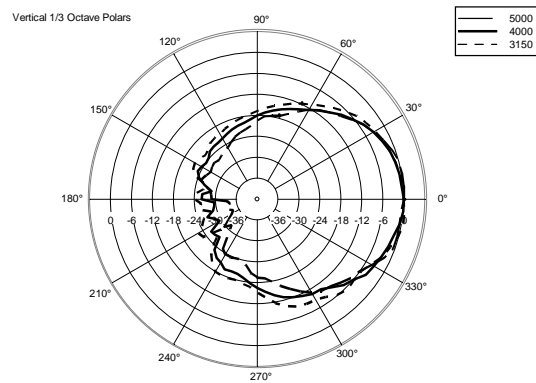
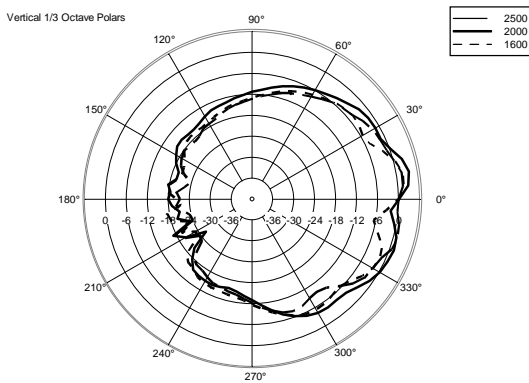
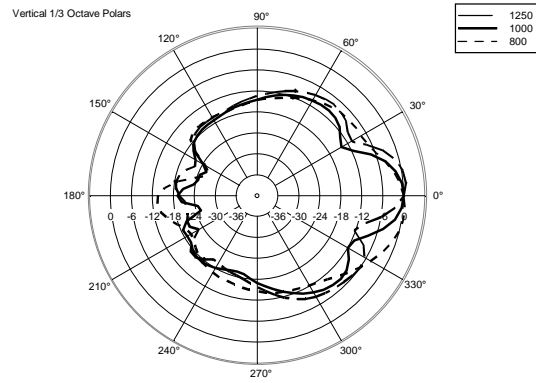
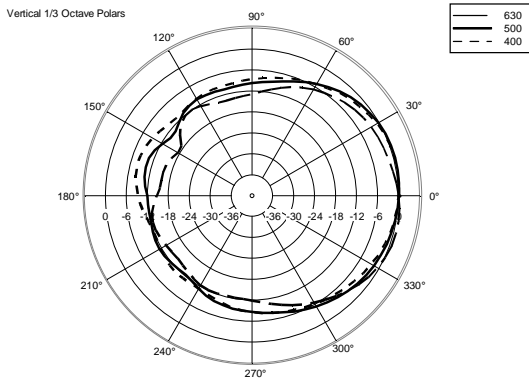
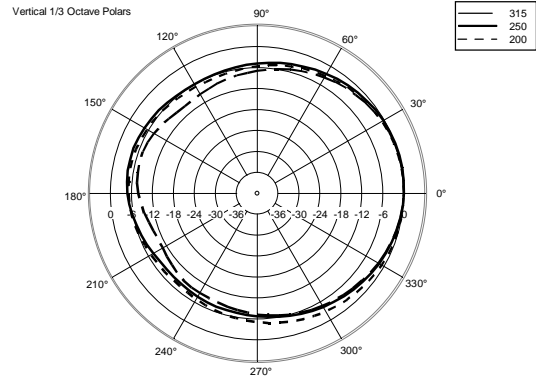
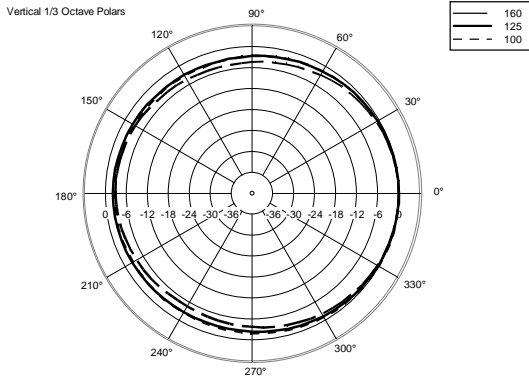

ACCESSORIES

AC NC-FB2 FLYING BRACKET NC12/15

PART NUMBER **13360201**

EAN: 8024530007478



HORIZONTAL BRACKET H-BR 2X NC15

PART NUMBER **13360193**

EAN: 8024530007409