

HDL 10-A

ACTIVE LINE ARRAY MODULE

DESCRIPTION

The very compact size, no compromise transducers and a unique composite cabinet design make the HDL 10-A the perfect tool in many situations. Ideal in live sound reinforcement and reliable installed situations. The HDL 10-A is the ideal choice when line array performance is needed and a fast and easy set up is a must. The system is powered from a 1400 Watt Peak Power 2 way digital amplifier, sound is processed from a powerful DSP.

The HDL 15-AS is the ideal flyable bass complement for the HDL 10-A array system.



FEATURES

- 1400 Watt Peak power - 700 Watt RMS
- 133 dB max SPL
- 65 Hz 20 kHz frequency response
- 2 x 8" Woofers
- 1 x 2" Compression Driver
- DSP controlled Input section with selectable presets
- Tour grade safe and solid variable mechanics
- Composite PP enclosure structurally wooden reinforced

TECHNICAL SPECIFICATIONS

Acoustical specifications	Frequency Response:	65 Hz ÷ 20000 Hz
	Max SPL @ 1m:	133 dB
	Horizontal coverage angle:	100°
	Vertical coverage angle:	15°
Transducers	Compression Driver:	1 x 2.0", 2.5" v.c
	Woofers:	2 x 8", 2.0" v.c
Input/Output section	Input signal:	bal/unbal
	Input connectors:	XLR
	Output connectors:	XLR
	Input sensitivity:	-2 dBu/+4 dBu
Processor section	Crossover Frequencies:	800 Hz
	Protections:	Thermal, RMS
	Limiter:	Soft Limiter
	Controls:	Cluster, HF, High curving, Indoor
Power section	Total Power:	1400 W Peak, 700 W RMS
	High frequencies:	400 W Peak, 200 W RMS
	Low frequencies:	1000 W Peak, 500 W RMS
	Cooling:	Convection
	Connections:	Powercon IN/OUT
Standard compliance	CE marking:	Yes
Physical specifications	Cabinet/Case Material:	PP Composite
	Hardware:	Rigging flyware
	Handles:	2 side
	Grille:	Steel
	Color:	Black
Size	Height:	294 mm / 11.57 inches
	Width:	569 mm / 22.4 inches
	Depth:	434 mm / 17.09 inches
	Weight:	20.4 kg / 44.97 lbs
Shipping informations	Package Height:	375 mm / 14.76 inches
	Package Width:	650 mm / 25.59 inches
	Package Depth:	500 mm / 19.69 inches
	Package Weight:	23 kg / 50.71 lbs



PART NUMBER

- **13040023**

HDL 10-A W
115V, White
EAN 8024530012403

- **13040022**

HDL 10-A W
220-240V, White
EAN 8024530012113

- **13040017**

HDL 10-A
115V, Black
EAN 8024530010850

- **13040016**

HDL 10-A
220-240V, Black
EAN 8024530010843

DATASHEET

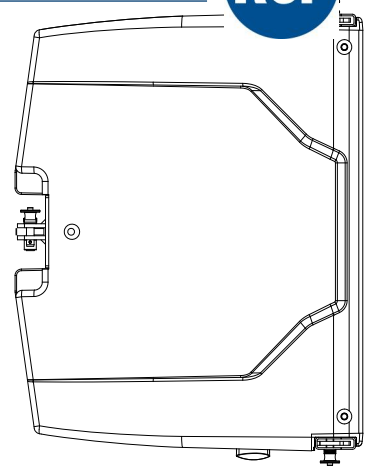
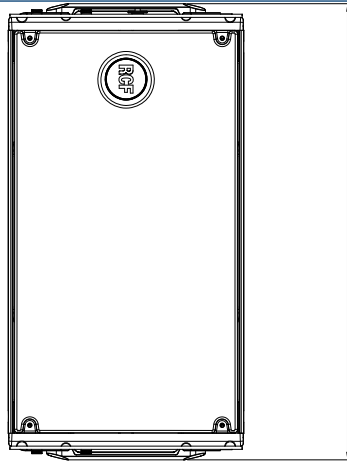
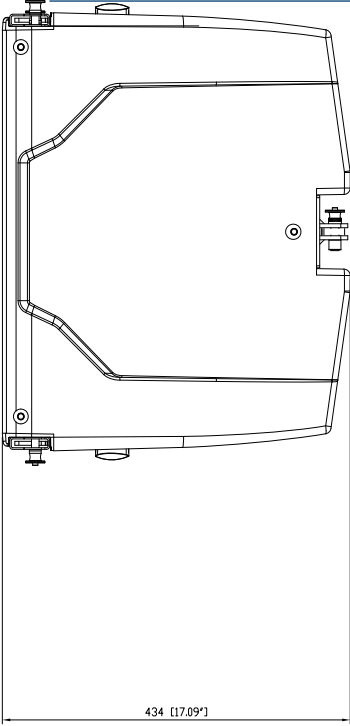

HDL10-A

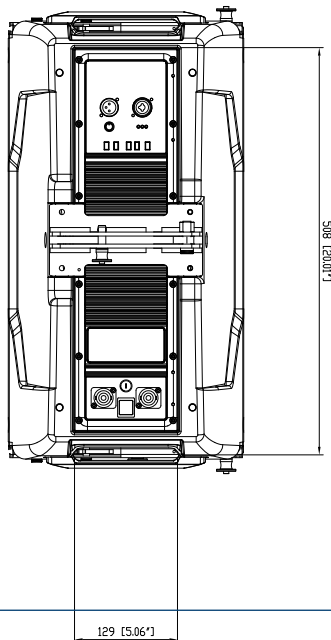
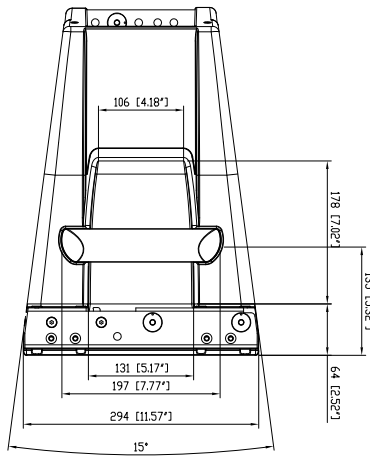

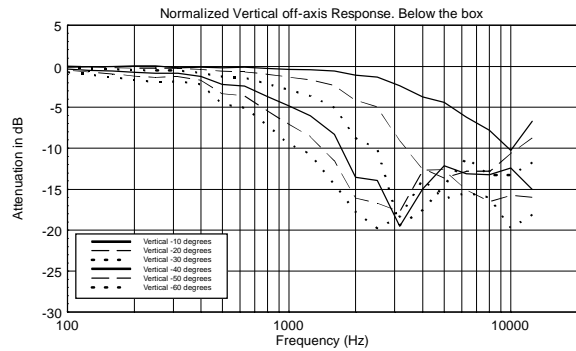
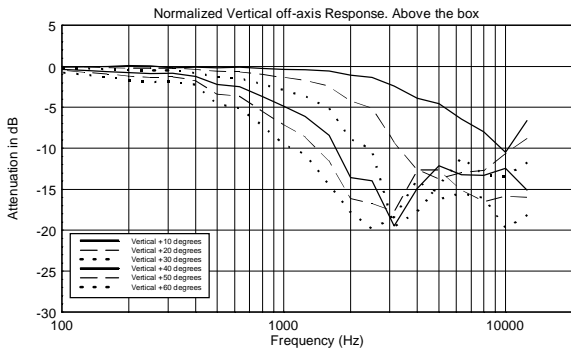
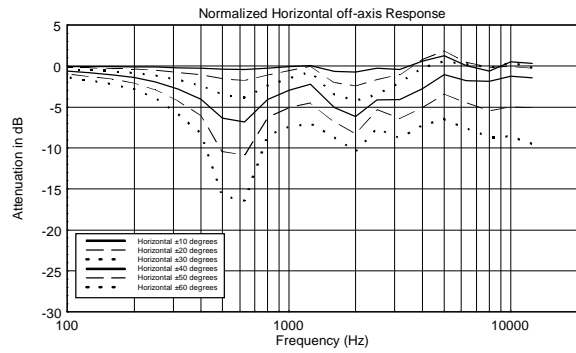
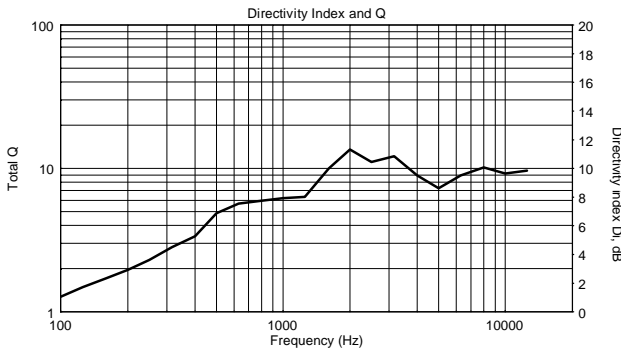
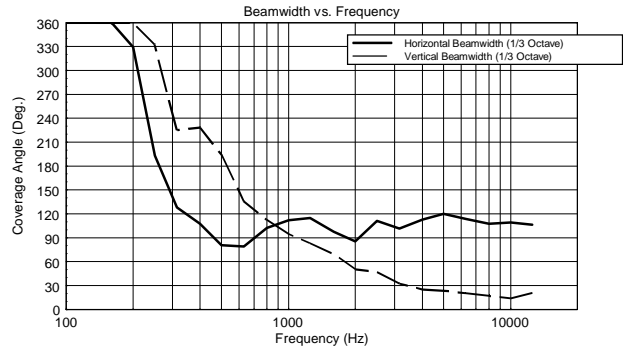
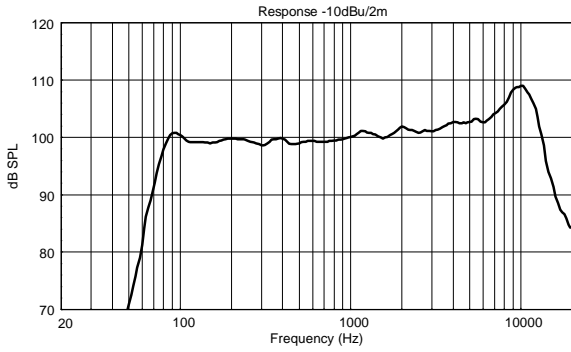

Horizontal 1/3 Octave Polars

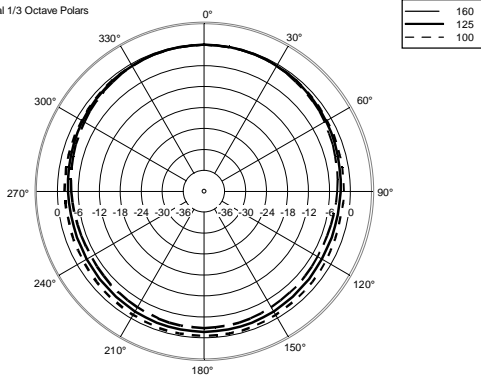

Horizontal 1/3 Octave Polars

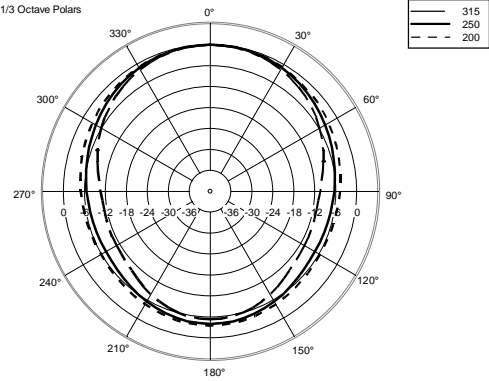

Horizontal 1/3 Octave Polars

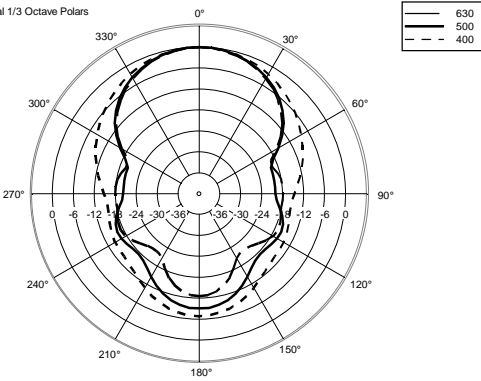

Horizontal 1/3 Octave Polars

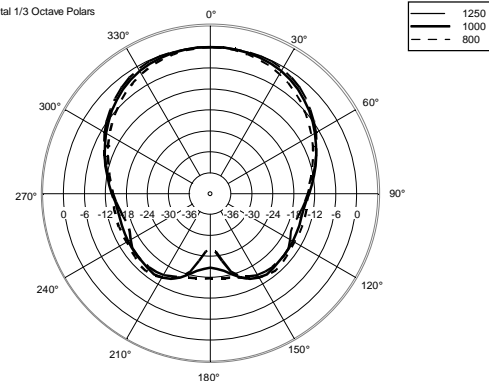

Horizontal 1/3 Octave Polars

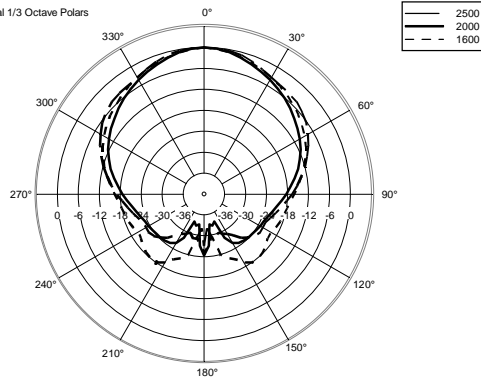

Horizontal 1/3 Octave Polars

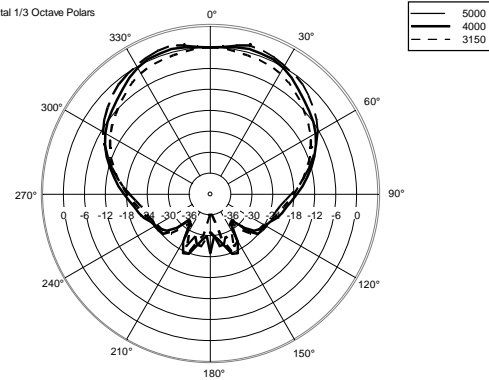

Horizontal 1/3 Octave Polars

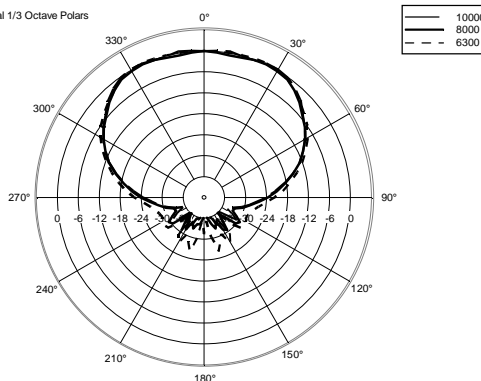

Horizontal One Octave Polars

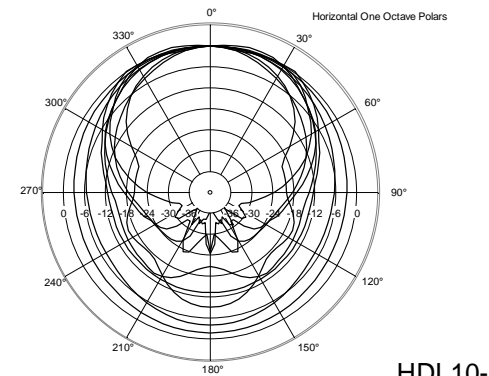

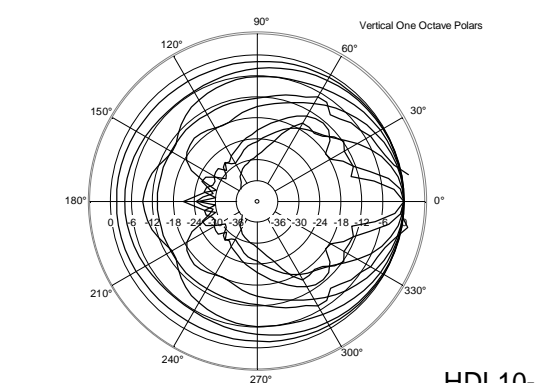
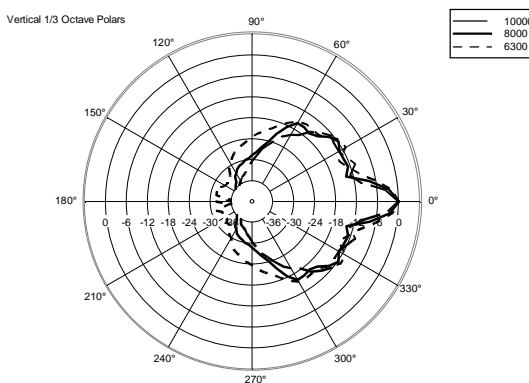
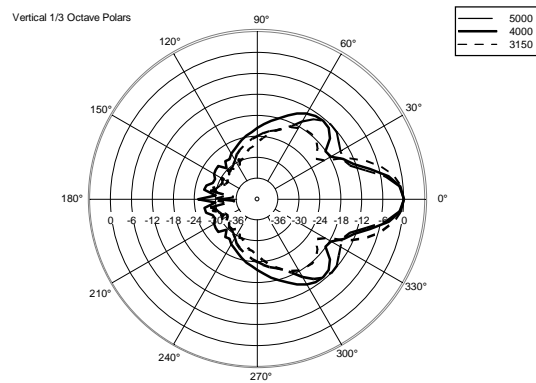
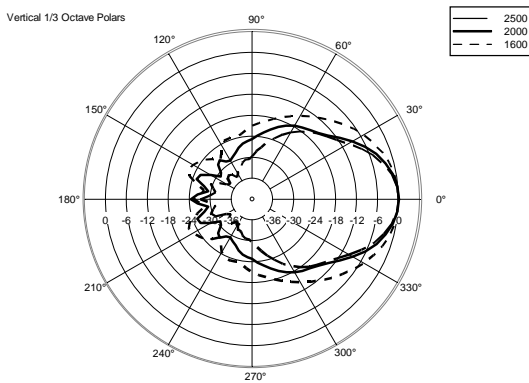
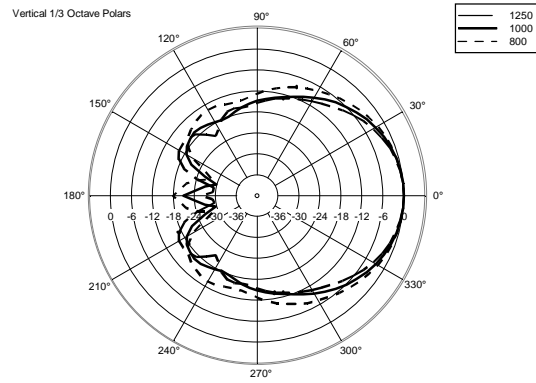
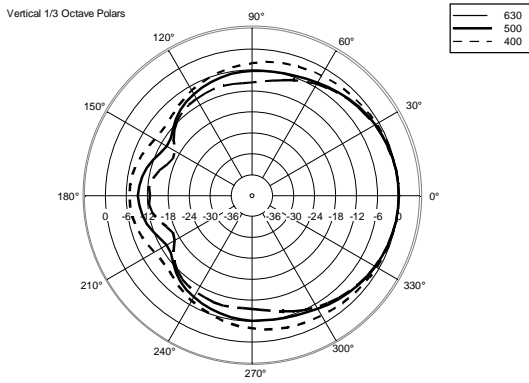
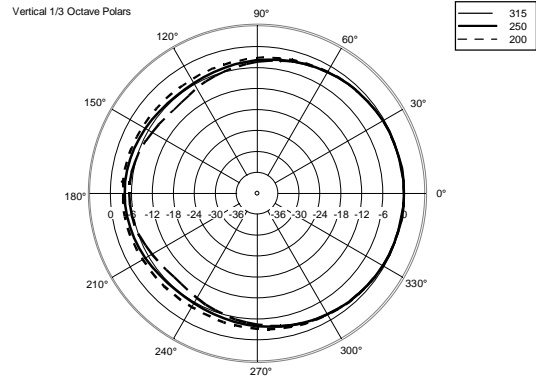
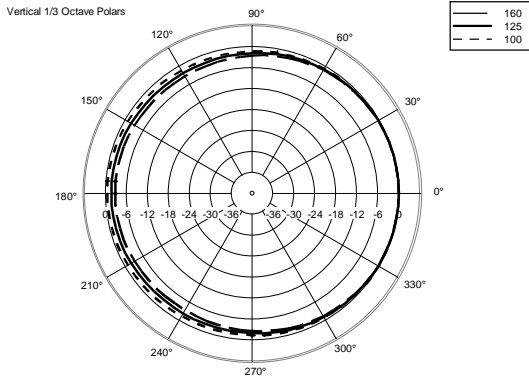

ACCESSORIES

AC 2X AZIMUT PLATE

PART NUMBER **13360351**
EAN: 8024530013516

AC POWER CABLE 6X TTL55

PART NUMBER **13360138**
EAN:

AC XLR-3M3F XLR CONN. 3MALE3FEMALEXCABLE

PART NUMBER **13360102**
EAN: 8024530006402

CABLES KIT CBL LK 25 MULTIPIN 10M

PART NUMBER **12399023**
EAN: 8024530013837

CABLES KIT CBL LK 25 MULTIPIN 20M

PART NUMBER **12399022**
EAN: 8024530013820

CABLES KIT CBL LKS 19 ARRAY FANOUT

PART NUMBER **12399024**
EAN: 8024530013905

CABLES KIT CBL LKS 19 BREAKOUT

PART NUMBER **12399026**
EAN: 8024530013929

CABLES KIT CBL LKS 19 POWER 10M

PART NUMBER **12399027**
EAN: 8024530013936

CABLES KIT CBL LKS 19 SUB FANOUT

PART NUMBER **12399025**
EAN: 8024530013912



CABLES KIT CBL LKS 25-2 FANOUT

PART NUMBER **12399021**
EAN: 8024530013813



CABLES KIT CBL POWER BOX 6X

PART NUMBER **13360145**
EAN: 8024530015534



CABLES KIT CBL POWERCON LINK 0.7M

PART NUMBER **12399031**
EAN: 8024530013738



CABLES KIT CBL POWERCON LINK 1.5M

PART NUMBER **12399030**
EAN: 8024530013721



CABLES KIT CBL POWERCON LINK 10M

PART NUMBER **12399028**
EAN: 8024530013707



CABLES KIT CBL POWERCON LINK 5M

PART NUMBER **12399029**
EAN: 8024530013714



FLY BAR PICKUP HDL 20-18

PART NUMBER **13360221**
EAN:



FLYBAR HDL 10

PART NUMBER **13360274**
EAN: 8024530012625



HOIST SPACING CHAIN TTL55

PART NUMBER **13360129**
EAN:



KART WITH WHEELS 4X HDL10

PART NUMBER **13360275**
EAN:



LIGHT BAR HDL 10

PART NUMBER **13360276**
EAN: 8024530012632



LINK BAR HDL15 TO HDL10

PART NUMBER **13360296**
EAN: 8024530016456



LKS 19-20 POWER CABLE

PART NUMBER **13360146**
EAN: 8024530013943



RAIN PROTECTION RP 2X HDL 20

PART NUMBER **13360283**
EAN: 8024530015886

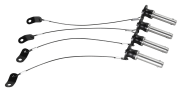

SPARE PINS FRONT 4X HDL20- HDL18

PART NUMBER **13360219**
EAN: 8024530015763

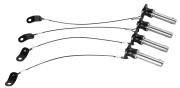

SPARE PINS REAR 4X HDL20- HDL18

PART NUMBER **13360220**
EAN: 8024530015770